

E655

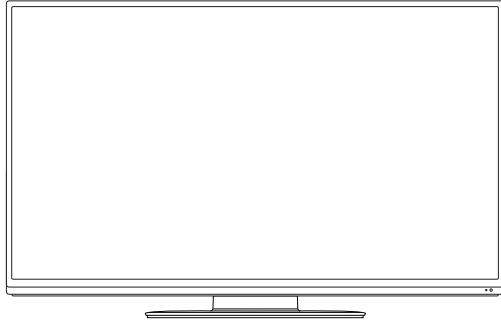

E585



E505

E425

E325

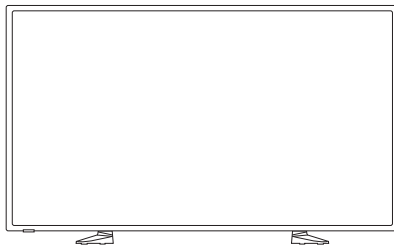

Index

Precautions And Reminders	English-1
Important Safety Instructions	English-2
Important Information	English-5
Declaration Of Conformity	English-11
Contents	English-13
Preparation	English-14
Attaching the Base	English-14
Using Cable Clamper	English-15
Preparing Your LCD TV For Wall Mounting (optional).....	English-15
Prohibit Portrait Condition Use	English-16
Place The TV On A Solid Surface	English-17
Antenna Connection	English-17
Battery Installation and Replacement.....	English-18
Connect To The Power Source	English-18
Power On/Off Your New LCD TV	English-19
Power Mode Status	English-19
Source Connection Guide	English-21
Operating Instructions	English-25
Using The Side Panel Controls	English-25
Using The Remote Control.....	English-26
Operating Range for the Remote Control.....	English-27
Timing Table	English-28
Navigating The On-Screen Menu	English-29
Video Menu	English-29
Audio Menu	English-30
Channels Menu	English-30
Setup Menu	English-31
USB Menu	English-33
Maintenance and Recycling	English-35
Care Of The Screen	English-35
Mobile Telephone Warning	English-35
End Of Life Directives.....	English-35
Manufacturer's Recycling and Energy Information.....	English-36
Disposing of your old NEC product	English-36
Energy Saving	English-36
Product Specification.....	English-37
RS-232C Port Specifications.....	English-43
Before Calling Service	English-44
Glossary	English-45
Limited Warranty	English-46
References	English-48

Precautions And Reminders

Do not place the TV in confined spaces or in a box when in use. Maintain ample ventilation for the TV when in use.

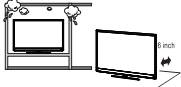

Do not open the TV cabinet.

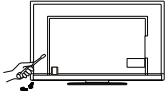

Call a NEC certified service personnel for any internal service needed for your TV.



Keep the TV away from direct sunlight, dust, humidity, smoke and oily areas.

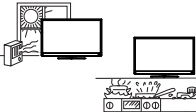

Unplug immediately if the TV falls.

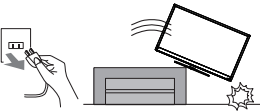

Unplug immediately if there is a TV malfunction such as a loss of audio / video, the presence of smoke, or a bad odor coming from the TV.



Unplug the AC cord from the AC outlet before cleaning. Do not use liquid cleaners or aerosol cleaners to clean the TV.



Do not place the TV near water such as a bathtub, washbasin, sink, laundry tub, swimming pool, or a damp basement. Unplug immediately if the TV has been exposed to rain or water.

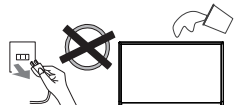

Do not cover or block any vents or openings. Inadequate ventilation may shorten the life of the TV and cause overheating.



Place the unit on a sturdy, even surface.



Do not insert any foreign objects into the TV cabinet. Unplug immediately if objects have fallen into the monitor.



Unplug the power cord from the outlet when the TV is not in use for long periods of time (days).



Notice for Remote Controller

Avoid Liquids



Avoid Aerosol Cleaners



Avoid Dropping



Important Safety Instructions

Read before operating equipment

Follow all warnings and instructions marked on this TV.

1. Read these instructions.
2. Keep these instructions.
3. Heed all warnings.
4. Follow all instructions.
5. Do not use this apparatus near water.
6. Clean only with dry cloth.
7. Do not block any ventilation openings. Install in accordance with the manufacturer's instructions.
8. Do not install near any heat sources such as radiators, heat registers, stoves, or other apparatus (including amplifiers) that produce heat.
9. Do not defeat the safety purpose of the polarized or grounding-type plug. A polarized plug has two blades with one wider than the other. A grounding type plug has two blades and a third grounding prong. The wide blade or the third prong are provided for your safety. If the provided plug does not fit into your outlet, consult an electrician for replacement of the obsolete outlet.
10. Protect the power cord from being walked on or pinched particularly at plugs, convenience receptacles, and the point where they exit from the apparatus.
11. Only use attachments / accessories specified by the manufacturer.
12. Use only with the cart, stand, tripod, bracket, or table specified by the manufacturer, or sold with the apparatus. When a cart is used, use caution when moving the cart/apparatus combination to avoid injury from tip-over.



13. Unplug this apparatus during lightning storms or when unused for long periods of time.
14. Refer all servicing to qualified service personnel. Servicing is required when the apparatus has been damaged in any way, such as power-supply cord or plug is damaged, liquid has been spilled or objects have fallen into the apparatus, the apparatus has been exposed to rain or moisture, does not operate normally, or has been dropped. Unplug immediately if the monitor faces above condition.
15. The TV complies with the recommended safety standards for stability. Do not put excessive force on the front or top of the cabinet. This could cause the product to tip over and cause damage and / or personal injury.
16. If monitor or glass is broken, do not come in contact with the liquid crystal and handle with care.

17. Follow instructions for wall, shelf or ceiling mounting as recommended by the manufacturer.
18. An outdoor antenna should not be located near overhead power lines or any electrical circuits.
19. If an outside antenna is connected to the receiver, confirm that the antenna system is grounded to protect against voltage surges and built up static charges. Section 810 of the National Electric Code, ANSI / NFPA No. 70-1984, provides information with respect to proper grounding for the mast and supporting structure, grounding of the lead-in wire to an antenna discharge unit, size of grounding connectors, location of antenna discharge unit, connection to grounding electrodes and requirements for the grounding electrode.
20. Rest your eyes periodically by focusing on an object at least 5 feet away. Blink often.
21. Do not place any heavy objects on the power cord.
Damage to the cord may cause shock or fire.
22. Do not use monitor in high temperature, humid, dusty, or oily areas.
23. Do not bend, crimp or otherwise damage the power cord.
24. Apparatus shall not be exposed to dripping or splashing and no objects filled with liquids, such as vases, shall be placed on the apparatus.

NOTE: To the TV system installer: This reminder is provided to call attention to Article 820-44 of the National Electric Code that provides guidelines for proper grounding and, in particular, specifies that the cable ground shall be connected to the grounding system of the facility, as reasonably close to the point of cable entry as possible

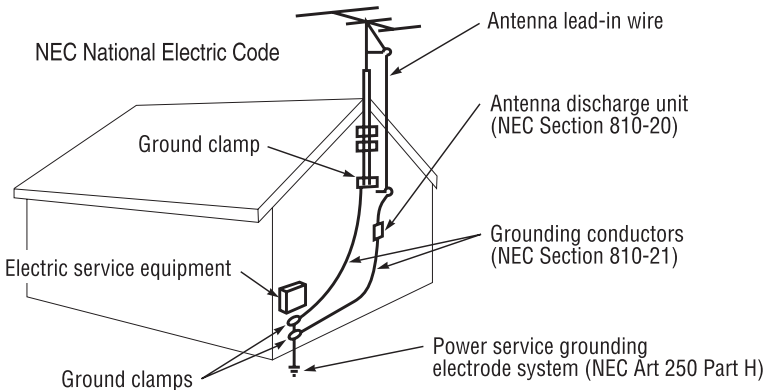



WARNING: To prevent the spread of fire, keep candles or other open flames away from this product at all times.

IMPORTANT INFORMATION

If a television is not positioned in a sufficiently stable location, it can be potentially hazardous due to falling. Many injuries, particularly to children, can be avoided by taking simple precautions such as:

- Using cabinets or stands recommended by the manufacturer of the television.
- Only using furniture that can safely support the television.
- Ensuring the television is not overhanging the edge of the supporting furniture.
- Not placing the television on tall furniture (for example, cupboards or bookcases) without anchoring both the furniture and the television to a suitable support.
- Not standing the televisions on cloth or other materials placed between the television and supporting furniture.
- Educating children about the dangers of climbing on furniture to reach the television or its controls.

Important Information



WARNING



TO PREVENT FIRE OR SHOCK HAZARDS, DO NOT EXPOSE THIS UNIT TO RAIN OR MOISTURE. ALSO, DO NOT USE THIS UNIT'S POLARIZED PLUG WITH AN EXTENSION CORD RECEPTACLE OR OTHER OUTLETS UNLESS THE PRONGS CAN BE FULLY INSERTED. REFRAIN FROM OPENING THE CABINET AS THERE ARE HIGH VOLTAGE COMPONENTS INSIDE.
REFER SERVICING TO QUALIFIED SERVICE PERSONNEL.



CAUTION



CAUTION: TO REDUCE THE RISK OF ELECTRIC SHOCK, MAKE SURE POWER CORD IS UNPLUGGED FROM WALL SOCKET. TO FULLY DISENGAGE THE POWER TO THE UNIT, PLEASE DISCONNECT THE POWER CORD FROM THE AC OUTLET. DO NOT REMOVE COVER (OR BACK). NO USER SERVICEABLE PARTS INSIDE. REFER SERVICING TO QUALIFIED SERVICE PERSONNEL.



This symbol warns user that uninsulated voltage within the unit may have sufficient magnitude to cause electric shock. Therefore, it is dangerous to make any kind of contact with any part inside this unit.



This symbol alerts the user that important literature concerning the operation and maintenance of this unit has been included. Therefore, it should be read carefully in order to avoid any problems.

CAUTION: Please use the power cord provided with this TV in accordance with the table below. If a power cord is not supplied with this equipment, please contact your supplier.

Plug Type	Plug Shape	Region	Voltage
North America		U.S.A./Canada	AC 120 V

Power source

This LCD TV operates on 120 volts 60 Hz, AC current. Insert the power cord into a 120 volts 60 Hz outlet. The mains plug is used as the disconnect device and shall remain readily operable.

To prevent electric shock from the TV, do not use with an extension cord, receptacle, or other outlet unless the blades and ground terminal can be fully inserted to prevent blade exposure.

Never connect the LCD TV to 50 Hz, direct current, or anything other than the specified voltage.

CAUTION:

Never remove the back cover of the LCD TV as this can expose you to very high voltages and other hazards. If the TV does not operate properly, unplug the LCD TV and call your authorized dealer or service center.

Adjust only those controls that are covered in the instructions, as improper changes or modifications not expressly approved by NEC could void the user's warranty.

Batteries installed warning

CAUTION: Incorrect usage of batteries can result in leaks or bursting. NEC recommends the following battery use:

- Do not mix battery brands.
- Danger of explosion if battery is incorrectly replaced. Replace only with the same or equivalent type.
- Do not combine new and old batteries. This can shorten the battery life or cause liquid leakage of the batteries.
- Remove dead batteries immediately to prevent battery acid from leaking into the battery compartment.
- Do not touch exposed battery acid as it may injure skin.
- Remove the batteries if you do not intend to use the remote control for a long period of time.
- The batteries shall not be exposed to excessive heat such as sunshine, fire or the like.

Image persistence

- Please be aware that LCD Technology may experience a phenomenon known as Image Persistence. Image Persistence occurs when a residual or “ghost” image of a previous image remains visible on the screen. Unlike CRT monitors, LCD monitors’ image persistence is not permanent, but constant images being displayed for a long period of time should be avoided. To alleviate image persistence, turn off the monitor for as long as the previous image was displayed. For example, if an image was on the monitor for one hour and a residual image remains, the monitor should be turned off for one hour to erase the image.

NOTE: As with all personal display devices, NEC DISPLAY SOLUTIONS recommends displaying moving images and using a moving screen saver at regular intervals whenever the screen is idle or turning off the monitor when not in use.

CAUTION:

These servicing instructions are for use by qualified service personnel only. To reduce the risk of electric shock, do not perform any servicing other than that contained in the operating instructions unless you are qualified to do so.

Ventilation

The slots and openings in the TV are provided for necessary ventilation. To ensure reliable operation of the TV and to protect it from overheating, these slots and openings must never be blocked or covered.

Unless proper ventilation is provided, the TV may gather dust and get dirty. For proper ventilation, observe the following:

- Do not install the TV face up, down or sideways.
- Do not install the TV turned over or upside down.
- Never cover the slots and openings with a cloth or other materials.
- Never block the slots and openings by placing the TV on a bed, sofa, rug or other similar surface.
- Never place the TV in a confined space, such as a bookcase or built-in cabinet, unless proper ventilation is provided.

Leave some space around the TV set as shown below. Otherwise, air-circulation may be inadequate and will cause overheating, which may cause a fire or damage to the TV set.

Install on the wall

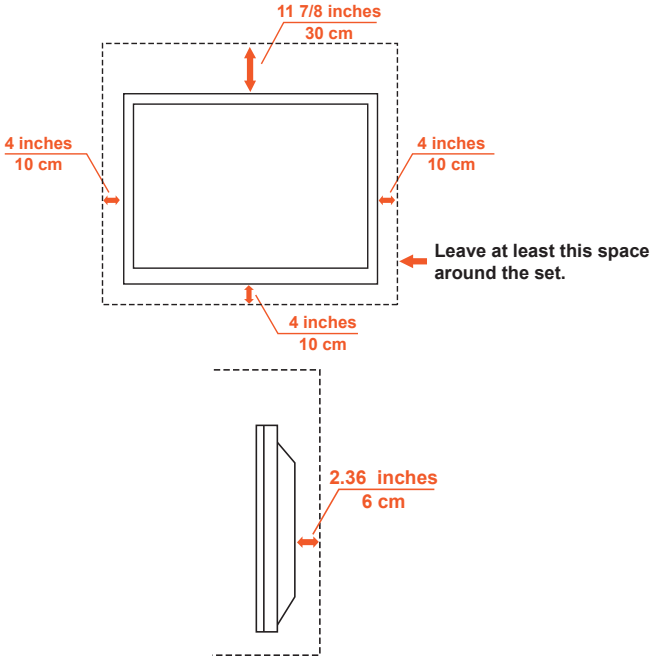

For use only with UL Listed Wall Mount Bracket with minimum weight / load:
Please refer to the Specification on page 38 and page 41 .
Unit without base weight: The equipment and its associated mounting means
still remain secure during the test.
Used wall mounting kit, VESA-compatible wall bracket distance, diameter of
Screw dimension: Please refer to the Specification on page 38 and
page 41 .

Installed with stand

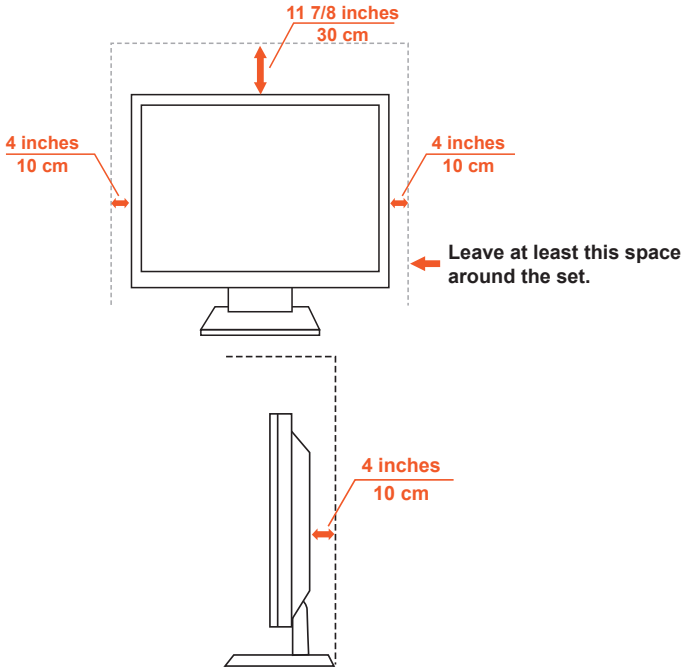

Never install the TV set where air-circulation is blocked.

Objects and ventilation holes

Never push objects of any kind into the TV through the cabinet slots as they may touch dangerous voltage points or short out parts that could result in a fire or an electric shock. Do not place any objects on the TV.

License Notice and Trademark Acknowledgement

Windows is a registered trademark of Microsoft Corporation.
NEC is a registered trademark of NEC Corporation.
All other brands and product names are trademarks or registered trademarks of their respective owners.



HDMI, the HDMI logo and High-Definition Multimedia Interface are trademarks or registered trademarks of HDMI Licensing LLC in the United States and other countries.



Please keep the factory default settings as shipped, in which the product can meet ENERGY STAR® requirements.



Manufactured under license from Dolby Laboratories. Dolby and the double-D symbol are trademarks of Dolby Laboratories.

Declaration Of Conformity

This device complies with Part 15 of FCC Rules. Operation is subject to the following two conditions. (1) This device may not cause harmful interference, and (2) this device must accept any interference received, including interference that may cause undesired operation.

U.S. Responsible Party:	NEC Display Solutions of America, Inc.
Address:	500 Park Boulevard, Suite 1100 Itasca, Illinois 60143
Tel. No.:	(630) 467-3000

Type of Product:	LCD TV	
Equipment Classification:	Class B Peripheral	
Model:	E655	E425
	E585	E325
	E505	



We hereby declare that the equipment specified above conforms to the technical standards as specified in the FCC Rules.

Canadian Department of Communications Compliance Statement

DOC: This Class B digital apparatus meets all requirements of the Canadian Interference-Causing Equipment Regulations.

C-UL: Bears the C-UL Mark and is in compliance with Canadian Safety Regulations according to CAN/CSA C22.2 No. 60065-03.

FCC Information:

1. Use the attached specified cables with the E655/E585/E505/E425/E325 color monitor so as not to interfere with radio and television reception.
 - (1) Please use the supplied power cord or equivalent to ensure FCC compliance.
 - (2) Please use the supplied shielded video signal cable, Mini D-SUB 15 pin to Mini D-SUB 15 pin.
2. This equipment has been tested and found to comply with the limits for a Class B digital device, pursuant to part 15 of the FCC Rules. These limits are designed to provide reasonable protection against harmful interference in a residential installation. This equipment generates, uses and can radiate radio frequency energy and, if not installed and used in accordance with the instructions, may cause harmful interference to radio communications. However, there is no guarantee that interference will not occur in a particular installation. If this equipment does cause harmful interference to radio or television reception, which can be determined by turning the equipment off and on, the user is encouraged to try to correct the interference by one or more of the following measures:
 - Reorient or relocate the receiving antenna.
 - Increase the separation between the equipment and receiver.
 - Connect the equipment into an outlet on a circuit different from that to which the receiver is connected.
 - Consult the dealer or an experienced radio / TV technician for help.

FCC CAUTION

To assure continued compliance and possible undesirable interference, ferrite cores may be used when connecting this LCD TV to video equipment; and maintain at least 400mm spacing to other peripheral device.

FCC warning

Changes or modifications not expressly approved by the party responsible for compliance with the FCC Rules could void the user's authority to operate this equipment.

Cables

Connections to this device must be made with shielded cables with metallic RF / EMI connector hoods to maintain compliance with FCC Rules and Regulations.

Canadian notice

CAN ICES-3 (B) / NMB-3(B)

Standard Television Receiving Apparatus-Appareil de réception télévision ordinaire, Canada, BETS-7/NTMR-7

If necessary, the user should contact the dealer or an experienced radio/television technician for additional suggestions. The user may find the following booklet, prepared by the Federal Communications Commission, helpful: "How to Identify and Resolve Radio-display Interference Problems." This booklet is available from the U.S. Government Printing Office, Washington, D.C., 20402, Stock No. 004-000-00345-4.

Contents

Your new NEC monitor box^{*1} should contain the following:

- Monitor (1)
- Remote control (1)
- 1.5 V AAA batteries (2)
- Power cord (1)
- D-sub cable (1)
- User's manual (1)

E655



Wireless Remote Control
and AAA Batteries

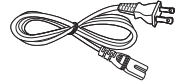

Power Cord

E585 / E505 / E425 / E325



Video Signal Cable
(Mini D-SUB 15 pin to
Mini D-SUB 15 pin)

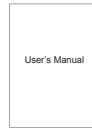

User's Manual

NOTE:

*1: Remember to save your original box and packing material to transport or ship the monitor.

*2: The following stand base and screw are option parts.



(E655)

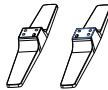

(E585)
Stand Base

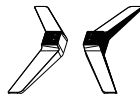

(E505/E425/E325)



E655: M6 (16mm) x 4
E585: M4 (14mm) x 6
E505: M6 (20mm) x 4
E425/E325: M4 (20mm) x 4
Stand Screw

Preparation

IMPORTANT: Do not apply pressure to the TV screen display area which may compromise the integrity of the display. The manufacturer's warranty does not cover user abuse or improper installations.

Attaching the Base

E655

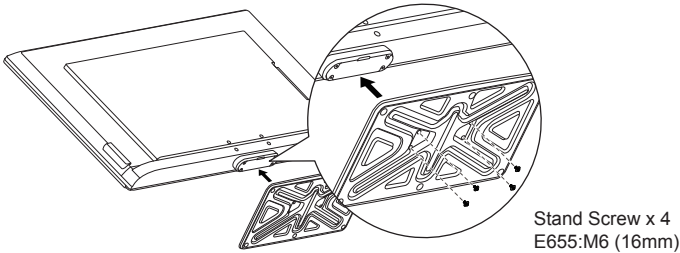

E585

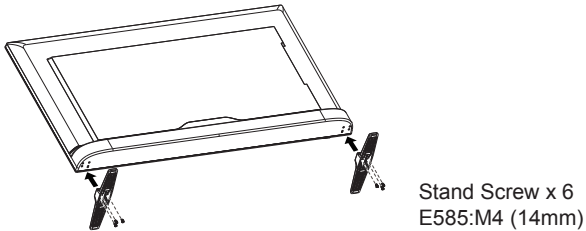

E505 / E425 / E325

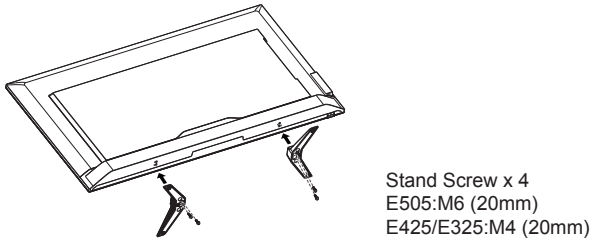

1. Place the TV face down on a soft and flat surface to prevent scratching and damage.
2. Carefully align the base to the button of the TV and fasten the screws with a cross-head screwdriver.

CAUTION: The base of the stand is very heavy. Install with care to avoid injury such as dropping the base onto one's foot.

Using Cable Clamper

Tie the cables together using the cable clamper.

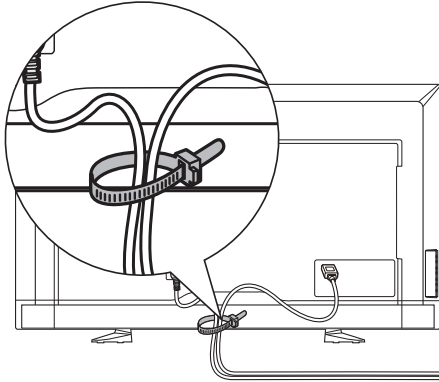

Preparing Your LCD TV For Wall Mounting (optional)

We suggest that you keep your TV at least 2.36 inches (60 mm) from the wall to prevent cable interference. Before mounting your TV on the wall, you need to remove the base. For your safety, only mount with a UL listed wall mount bracket that supports the weight of the TV. (Please see page 38 and page 41)

To attach a wall mount bracket to your TV:

E655

step 1

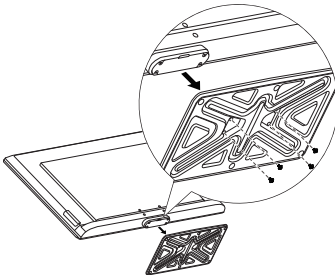

step 2

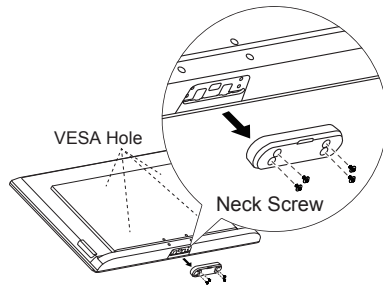

1. Loosen the screws at the bottom of the base, and remove the base.
2. Loosen the screws at the bottom of the stand to remove the stand.
3. Secure the wall mount bracket to the back of your TV using four M6 screws.

screen size (inches)	required pitch (mm)	VESA Hole depth
65	400 × 400	4 × M6 (30mm)

CAUTION: If you skip the step 1 and loosen the screws for stand directly, please be sure to hold the base tightly to avoid dropping the base.

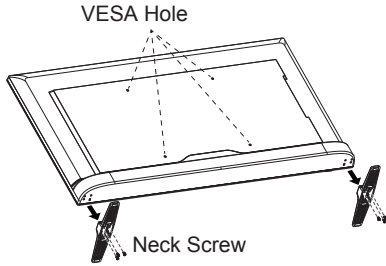
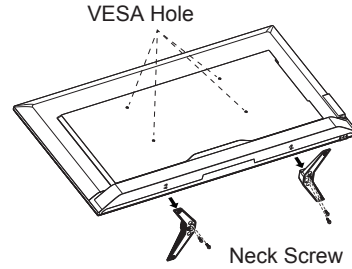
E585**E505/E425/E325**

1. Loosen the screws on the button of the base, and remove the base.
2. Secure the wall mount bracket to the back of your TV using four M4 screws (for 32"/42" only) or M6 screws (for 50"/58" only).

screen size (inches)	required pitch (mm)	VESA Hole depth
58	400 × 400	4 × M6 (22mm)
50	200 × 400	4 × M6 (15mm)
42	200 × 200	4 × M4 (15mm)
32	100 × 100	4 × M4 (12.5mm)

NOTE:

Wall mounting solution is not included with the unit and is sold separately. Contact your NEC representative for details. It is necessary to provide screw of appropriate length (Wall mount bracket thickness + VESA Hole depth).

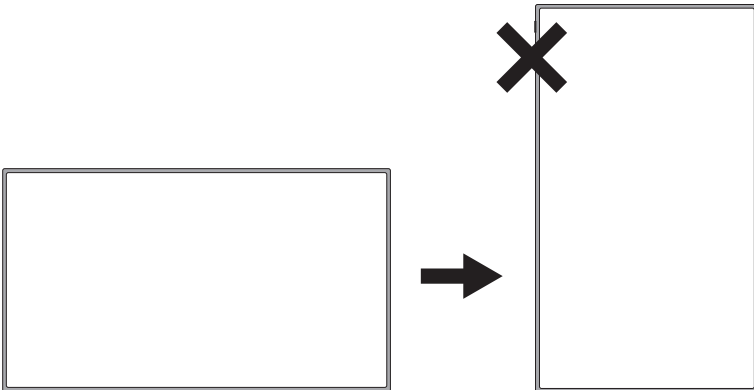
Prohibit Portrait Condition Use**CAUTION:**

Do not rotate the display from landscape to portrait.

Place The TV On A Solid Surface

Ensure that the LCD TV is placed in a position to allow free flow of air.

Do not cover the ventilation openings on the back cover.

Do not place the TV near any open flames.

Do not allow the TV to be placed in an environment where it can be exposed to heat, direct sunlight, or rain and water.

Do not expose the equipment to any liquid.

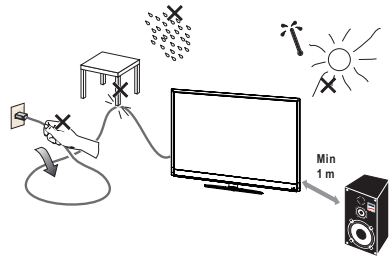

Antenna Connection

Unless your LCD TV is connected to a cable TV system or to a centralized antenna system, a good outdoor color TV antenna is recommended for best television performance. However, if you are located in an exceptionally good signal area that is free from interference and multiple image ghosts, an indoor antenna may be sufficient.

When using a 75-Ohm coaxial cable system, connect the CATV coaxial cable to the AIR/CABLE (75-Ohm) terminal. Or if you have an antenna, connect the coaxial cable to the same AIR/CABLE terminal.

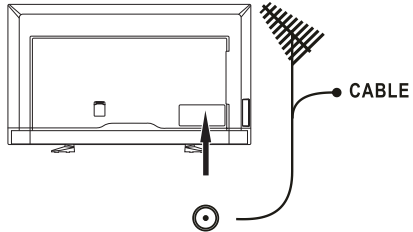

Battery Installation and Replacement

The remote control is powered by two 1.5V AAA batteries. To install or replace batteries:

1. Open the battery cover of the remote control by pushing and pulling it in the direction of the arrow.
2. Insert two new “AAA” size batteries for the remote control. When replacing old batteries, push them towards the springs and lift them out.
3. Match the batteries to the (+) and (-) marks in the battery compartment.
4. Insert the bottom of the battery, the (-) side, into the battery compartment first, push towards the springs and insert the top of the battery, the (+) side, into place. Do not force the battery into the battery compartment.
5. Close the battery cover making sure the tabs rest in the corresponding holes and push down the cover until it clicks shut.

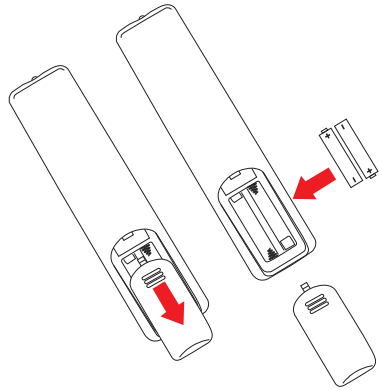

Connect To The Power Source

The TV should be installed close to an easily accessible power outlet. Fully insert the prongs into the power outlet socket. A loose connection may cause image degradation.

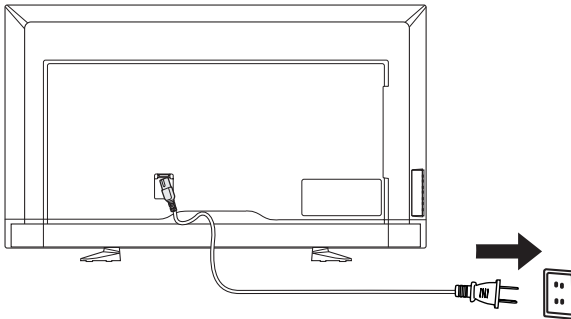

If there is power to the TV, the front LED at the bottom of the TV will be either none or red. A red LED means the TV is in standby mode.

Power On/Off Your New LCD TV

Press the power button on the remote control or press the power button located on the side of the TV. The TV will power on.

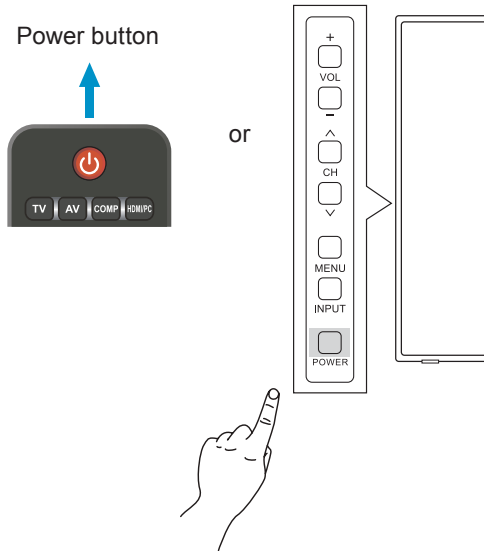

Power Mode Status

Mode	On	Standby	Warming up
LED Status	None	Red	Blinking Red

When in on mode, the Monitor operates as follows if no external signal is input.

1. When the external device is connected to the VGA terminal, the NO SIGNAL menu is displayed and 15 seconds later the Monitor switches to warming up mode.
2. In warming up mode, when the Monitor receives a signal from an external VGA device, it switches automatically to on mode.

NOTE:

Note that in warming up mode, the Monitor does not switch automatically to on mode even if a signal is input from an external device using HDMI, component video or composite video.

If the power cord is unplugged during warming up mode, the Monitor will start in standby mode the next time it is turned on.

3. When the external device is connected to another terminal (HDMI, component video, composite video), the NO SIGNAL menu is displayed and 15 seconds later the Monitor switches to standby mode.

4. In standby mode, press the power button on the remote control or on the side panel to switch the Monitor to on mode.

NOTE:

Note that in standby mode, the Monitor does not switch automatically to on mode even if a signal is input from an external device using VGA, HDMI, component video or composite video.

If the power cord is unplugged during standby mode, the Monitor will start in the same standby mode the next time it is turned on.

TIP:

When Home mode is set under Energy Options in the on-screen display menu, the Monitor switches to power saving mode if no external signal is input.

When Retail mode is set under Energy Options in the on-screen display menu, the Monitor does not switch to power saving mode when no external signal is input.

When On is set under Auto Power Off in the on-screen display menu, the Monitor automatically turns off if the user does not operate the Monitor for more than 4 hours.

When the sleep timer has been set in the on-screen display menu, the Monitor automatically turns off after the set time has elapsed.

Source Connection Guide

E655

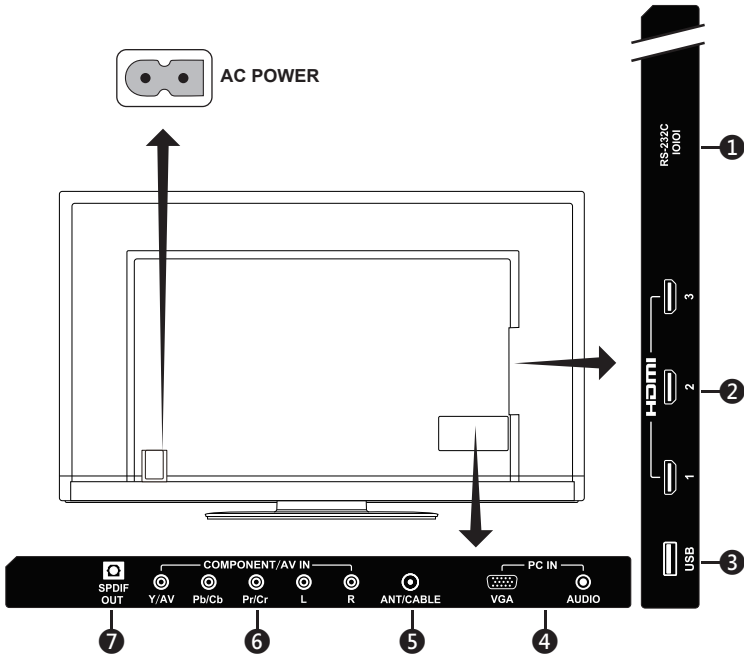

1. **RS-232C** – Connect to your PC, and receive the control commands from the PC.
2. **HDMI (HDMI1, HDMI2, HDMI3)** – Connect to your HDMI devices.
3. **USB port** – Used for accessing photo, music, and movie files.
4. **PC IN (VGA / AUDIO)** – Connect to your PC video and audio.
5. **ANT / CABLE** – Connect to an RF antenna or Analog Cable system.
6. **COMPONENT / AV IN –**
 - Component: Connect to digital video equipment to the Video Green (Y), Blue (Pb), Red (Pr) jacks, and matching Audio White (L) and Red (R) jacks.
 - Composite: Connect to digital video equipment to the Video Green (AV), jacks, and matching Audio White (L) and Red (R) jacks.
7. **SPDIF OUT-** Use a digital audio cable to connect to stereo home theater system.

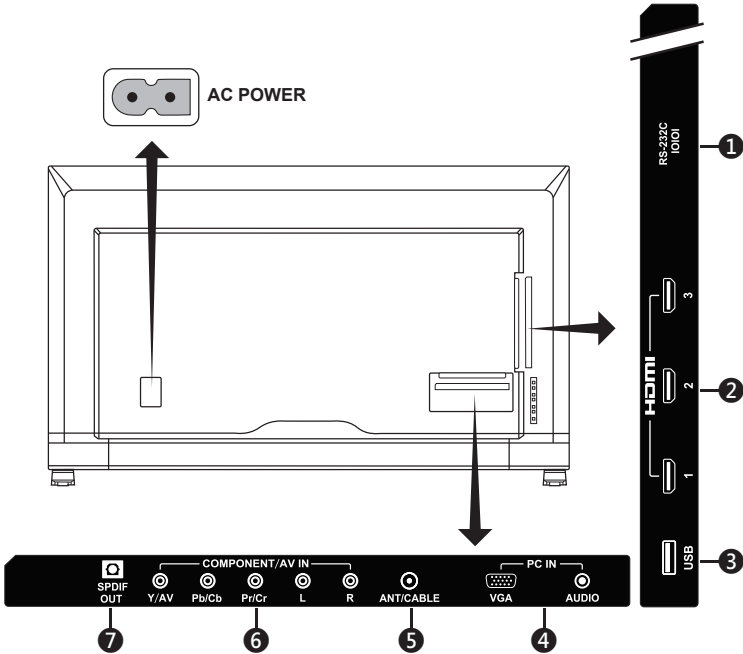

1. **RS-232C** – Connect to your PC, and receive the control commands from the PC.
2. **HDMI (HDMI1, HDMI2, HDMI3)** – Connect to your HDMI devices.
3. **USB port** – Used for accessing photo, music, and movie files.
4. **PC IN (VGA / AUDIO)** – Connect to your PC video and audio.
5. **ANT / CABLE** – Connect to an RF antenna or Analog Cable system.
6. **COMPONENT / AV IN** –
 - Component: Connect to digital video equipment to the Video Green (Y), Blue (Pb), Red (Pr) jacks, and matching Audio White (L) and Red (R) jacks.
 - Composite: Connect to digital video equipment to the Video Green (AV), jacks, and matching Audio White (L) and Red (R) jacks.
7. **SPDIF OUT**- Use a digital audio cable to connect to stereo home theater system.

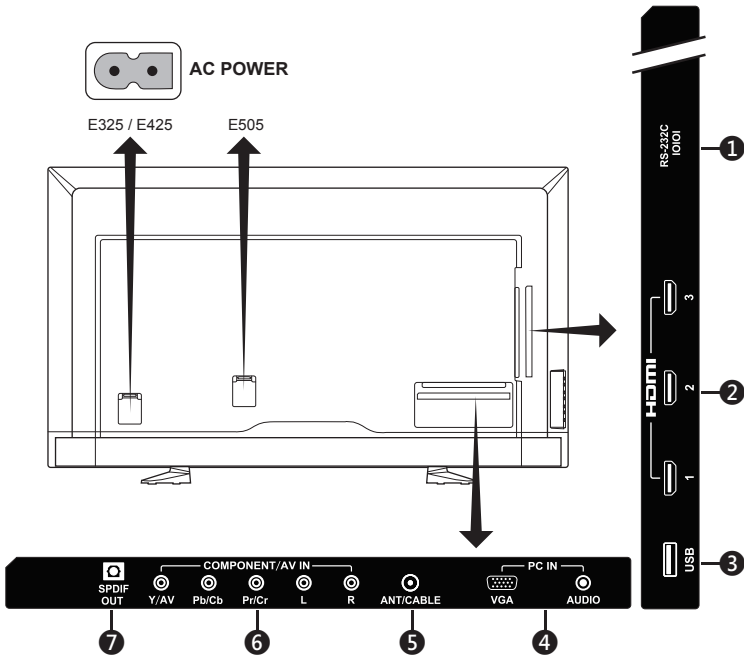

1. **RS-232C** – Connect to your PC, and receive the control commands from the PC.
2. **HDMI (HDMI1, HDMI2, HDMI3)** – Connect to your HDMI devices.
3. **USB port** – Used for accessing photo, music, and movie files.
4. **PC IN (VGA / AUDIO)** – Connect to your PC video and audio.
5. **ANT / CABLE** – Connect to an RF antenna or Analog Cable system.
6. **COMPONENT / AV IN** –
 - **Component**: Connect to digital video equipment to the Video Green (Y), Blue (Pb), Red (Pr) jacks, and matching Audio White (L) and Red (R) jacks.
 - **Composite**: Connect to digital video equipment to the Video Green (AV), jacks, and matching Audio White (L) and Red (R) jacks.
7. **SPDIF OUT**- Use a digital audio cable to connect to stereo home theater system.

Once your AV device is connected, press the **Source** button on the remote control to select the relevant source to view. (ex: Press **COMP** button to select “Component” if you have connected a source to the Component input.)



Operating Instructions

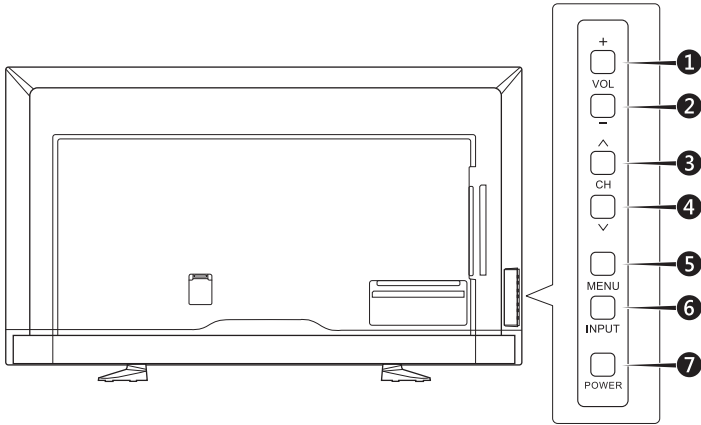

Using The Side Panel Controls

1.	VOL +	Press to increase the volume. Press this button to shift Right in the OSD menu.
2.	VOL -	Press to decrease the volume. Press this button to shift Left in the OSD menu.
3.	CH ^	Press to change channels. Press this button to shift up in the OSD menu.
4.	CH v	Press to change channels. Press this button to shift down in the OSD menu.
5.	MENU	Press to open or exit the OSD (On-Screen Display) menu.
6.	INPUT	Press to select the input source.
7.	POWER	Press to turn on / off (standby) the TV.

Using The Remote Control

(Power)

Press to turn On/Off (standby) the power. (NOTE: To completely turn off the power, unplug the power cord from the power outlet.)

TV

Press to choose ATSC/NTSC tuner source mode.

AV

Press to choose Composite source mode.

COMP

Press to choose Component source mode.

HDMI/PC

Press repeatedly to choose PC IN or HDMI source mode.

0 ~ 9 / —

Press to select channel (Press "—" to choose the sub-channel).

PRE CH

Press to display the previous channel.

Source

Press repeatedly to choose the various input sources.

Mute

Switch the sound On / Off.

VOL + / VOL —

Press + or — to adjust the volume.

CH + / CH —

Press + or — to browse through the channels.

Exit

Press to exit the OSD menu.

Display

Press to show the information about the input source and tuner channel.

FAV

Press to display the Favorite List.



Menu

Press to open the OSD menu.

▲, ▼, ◀, ▶, OK

Press to select or confirm the various function items on the menu.

◀◀, ■, ▶▶, ▶▶▶

Use in the USB menu and HDMI CEC function.

MTS

Press to activate the NTSC tuner sounds such as Stereo, SAP, Mono-tone, and languages of the digital tuner.

Wide

Press to choose the display aspect ratio: Normal / Zoom / Wide / Cinema / Auto (Ratio availability varies by video inputs.)

Picture

Press to choose the picture mode: Dynamic / Standard / Energy Savings / Theater / Game (*Only for E655 model*) / Custom.

Audio

Press to choose sound mode: Standard / Movie / Music / News / Custom.

CH-List

Press to display the Channel List.

C C

Press to activate the Closed Caption.

Operating Range for the Remote Control

Point the top of the remote control toward the LCD TV's remote sensor during button operation.

Use the remote control within a distance of about 7 m (23 ft.) from remote control sensor or at a horizontal and vertical angle of within 30° within a distance of about 3.5 m (10 ft.).

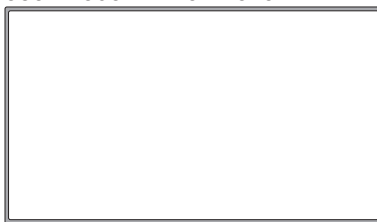
E655**E585 / E505 / E425 / E325****CAUTION:**

Important, the remote control system may not function when direct sunlight or strong illumination strikes the remote control sensor or when there is an object in the path.

Timing Table

Resolution	WXGA (E325)		FHD (E655/E585/E505/E425)		Horizontal		Vertical		Nominal Pixel Clock (MHz)
	VGA	DVI	VGA	DVI	Nominal Freq. (kHz)	Sync Polarity	Nominal Freq. (Hz)	Sync Polarity	
640 × 480@60Hz	•	•	•	•	31.469	–	59.94	–	25.175
720 × 400@70Hz	•	•	•	•	31.469	–	70.087	+	28.322
800 × 600@60Hz	•	•	•	•	37.879	+	60.317	+	40
1024 × 768@60Hz	•	•	•	•	48.363	–	60.004	–	65
1280 × 720@60Hz	•	•	•	•	45	–	60	+	74.25
1280 × 800@60Hz	▲	▲	•	•	49.702	–	59.81	+	83.5
1366 × 768@60Hz	• (Native)	• (Native)	Not support	•	47.712	+	59.79	+	85.5
1920 × 1080@60Hz	▲	▲	• (Native)	• (Native)	67.5	+	60	+	148.5

Resolution	WXGA (E325)		FHD (E655/E585/E505/E425)	
	HDMI	Component	HDMI	Component
480i 60Hz	•	•	•	•
480p 60Hz	•	•	•	•
720p 60Hz	•	•	•	•
1080i 60Hz	▲	▲	•	•
1080p 24Hz	▲	Not support	•	Not support
1080p 30Hz	▲	Not support	•	Not support
1080p 60Hz	▲	Not support	•	Not support

NOTE:

▲: Use Down-scaling function. Image quality is limited.

Navigating The On-Screen Menu

Press the **Menu** button to display and **Exit** button to close the main menu. Use the Navigation Ring to navigate, select, adjust or confirm an item on the OSD (On-Screen Display) menu.

NOTE: Some features may only be available in a particular source mode.

Video Menu

Video Menu adjusts video items.

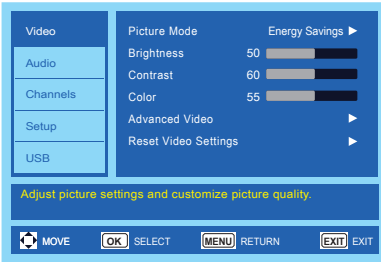

1. **Picture Mode**
Enter this menu to select from preset picture settings to optimize your TV's performance.
Dynamic / Standard / Energy Savings / Theater / Game (Only for E655 model) / Custom.
2. **Brightness**
Adjust picture brightness from 0 – 100.
3. **Contrast**
Adjust picture contrast from 0 – 100.
4. **Color**
Adjust picture color from 0 – 100.
5. **Advanced Video**
Select advanced video settings.
[Dynamic Backlight] (DCR)
Enhance the contrasts between darkness and brightness to optimization the picture.
[Color Temperature]
Select a choice from **Cool**, **Normal**, or **Warm**.
[Noise Reduction]
Set to reduce the video noise.

[Tint]

Adjust the hue (Red, Green, Blue) of the picture from R50 – G50.

[Sharpness]

Adjust object edges to optimize picture detail from 0 – 100.

[Adaptive Contrast]

Set to automatically adjust the picture detail and brightness.

[Aspect Ratio]

Adjust how the picture fills the screen.

Normal / Zoom / Wide / Cinema / Auto

[Overscan (On/Off)]

Some video formats may require different scanning modes in order to best display the image.

On: Image size is larger than what can be displayed. The image edge will appear cropped. Approximately 95% of the image will be shown on the screen.

Off: Image size stays within the display area. The whole image is displayed on the screen.

NOTE: When you use a computer with HDMI out, please set "OFF".

[Motion 120Hz]

(Only for E655 model)

Eliminate motion blur with clear detail and smooth motion.

[Backlight]

Set the backlight brightness from 0 – 50.

6. **Reset Video Settings**

Reset video settings to factory default settings.

Audio Menu

Audio Menu provides an audio adjustment for user to modify the audio setting.

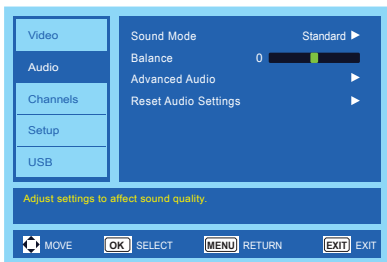

- 1. Sound Mode**
Select preset audio modes.
Standard / Movie / Music / News / Custom.
- 2. Balance**
Adjust the audio balance for the TV's internal left and right speakers from L50 — R50.
- 3. Advanced Audio**
Select advanced audio settings.
[Bass]
Enhance the low frequencies.
[Treble]
Enhance the high frequencies.
[Internal Speakers]
Select **Off** to turn off the internal speakers.
[Digital Output]
Select optical output options:
RAW or **PCM** (*Only available for digital channels or HDMI input source*)
[Audio Source]
Select audio sources in analog channels.
Mono / Stereo / SAP
(*Only available for analog channels*)
[Audio Language]
Select language options in digital channels. (*Only available for digital channels*)

4. Reset Audio Settings

Reset Audio settings to factory default settings.

Channels Menu

Channel Menu allows you to set your signal source options. According to various requirements in different source modes, certain features could be hidden (disabled) on the menu.

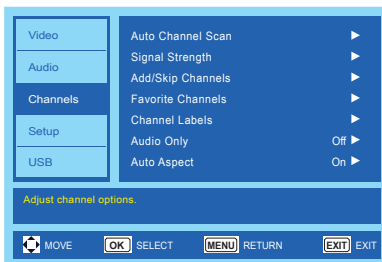

- 1. Auto Channel Scan**
Automatically search the available channels.
- 2. Signal Strength**
Access signal strength meter to help you adjust your antenna installation to optimize signal reception. (*Only available for digital channels*)
- 3. Add/Skip Channels**
Manually add or skip channels to the channel list.
- 4. Favorite Channels**
Add channels to your favorite channel list.
- 5. Channel Labels**
Create labels to any channel.
- 6. Audio Only**
Play the audio only when picture is turned off. Any press of the button except the **(Power)** button on the remote control will turn on the picture.

7. Auto Aspect

Automatically adjust the picture aspect ratio according to the TV program.

Setup Menu

Setup Menu in TV mode is shown below. According to various requirements in different source modes, certain features could be hidden (disabled) on the menu.

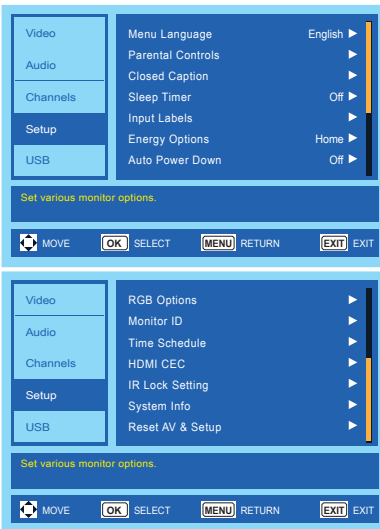

1. Menu Language

Select the menu display language.

English / Français / Español

2. Parental Controls

Set TV parental controls. This function blocks out the picture and sound of the selected rating levels.

The factory preset password to enter **Parental Controls** feature is a 4-digit number **0000**.

[Panel Lock]

Lock or unlock all buttons on the TV's panel.

[Block Unrated TV]

Block or unblock the unrated programs.

[US]

Set the parental control level using **Movie** memu or **US TV ratings lock** memu.

[Canadian]

Set the parental control level using **Canadian English** memu or **Canadian French** memu.

[Change Password]

Change the 4-digit password. You will have to enter the new password first, then enter again the new password to confirm. Make sure to keep your new password.

[Region 5]

Use Region 5 to block various types of movies and television programs based on ratings systems used in the USA that you feel may be inappropriate due to its content.

The Region 5 option will operate for Digital Channels (ATSC) only.

[Reset Region 5]

Clear the downloaded RRT5 rating information and restore to the factory default settings.

3. Closed Caption

Adjust the Closed Caption settings.

Caption Display / Analog Captions / Digital Captions / Digital CC Settings

4. Sleep Timer

Select how long the TV will take to automatically turn itself off.

Off / 5 / 10 / 15 / 30 / 60 / 90 / 120 / 180 / 240 (minutes)

5. Input Labels

Create labels for the devices connected to your TV. *(Only available for Non TV input source)*

6. **Energy Options**
Home mode is intended for home use, and will save much energy. In this mode, the Monitor automatically switches to power saving mode when no external signal is input.
Retail mode is a relatively more energy consuming mode.
 In this mode, the Monitor does not switch to power saving mode when no external signal is input.
7. **Auto Power Down**
 Select **On** to enable your TV to turn off automatically when you do not press any buttons in 4 hours.
8. **RGB Options**
(Only available for VGA input, and when there is VGA signal input)
[Auto Adjust]
 Automatically adjust the image settings such as position.
[H-Position]
 Adjust horizontal position.
[V-Position]
 Adjust vertical position.
[Clock]
 Set to the minimum level if noise occurs.
[Phase]
 Eliminate flicker and distortion.
[Reset RGB Options]
 Reset RGB options to factory default settings.
9. **Monitor ID**
 Set the monitor ID number from **1–100, All, or Group A–J.**
10. **Time Schedule**
 This function enables your TV to turn on and off automatically.
[Schedule Status]
 Select **On** to enable Time Schedule.
- [Current Time]**
 Set the current time before using this function.
- [Power On]**
 Set the time for your TV to turn on.
- [Power Off]**
 Set the time for your TV to turn off.
11. **HDMI CEC**
 This function enables you to control the HDMI CEC compliant device connected via the HDMI connector.
[Enable CEC]
 Select **On** to enable HDMI CEC.
[Audio Receiver]
 Select **On** to enable to return the audio signal to other speakers.
[Device List]
 Show the device list.
12. **IR Lock Setting**
 Select **On** to lock your remote control, and the remote control will disable to control the TV. Press **Display** button for 5 seconds can unlock it.
13. **System Info**
 Indicate the display information.
14. **Reset AV & Setup**
 Reset all **Audio, Video, and Setup** settings to factory default settings.

USB Menu

You could browse images, listen to musics, or play videos from USB device.

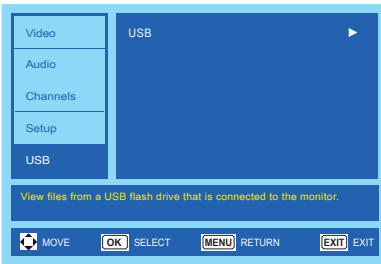

If no USB device is detected, TV will display the message: Please Insert USB flash drive.

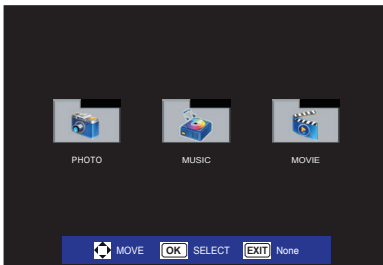

- Change input source to exit the USB mode.

To control while in folder:

- Press ▲, ▼, ◀, ▶ button to browse the files.
- Press **OK** button to open a folder or play the selected file.
- Press **EXIT** button to return to previous folder.

To control the operation bar:





- Press **OK / Menu** button to display operation bar on the bottom of screen.
- Press **Display** button to show operation bar and information window.
- Press ◀, ▶ button to select the item on operation bar.
- Press **EXIT** to hide operation bar.

To control while viewing photos:

- Select or press ▶/|| button to play image slideshow.
- Select or press ▶/|| button to pause the playing image.
- Select or press ◀ button to go to previous image.
- Select or press ▶ button to go to next image.
- Select or press ■ button to stop the playing image slideshow.
- Select or press **Display** button to show the playing image's information.
- Select to switch image size between the 4 styles by cycle.
Full / X1 / X2 / X4
- Select to rotate the image clockwise.
- Select to repeat images in the folder.
R_None / R_One / R_All
- Select to play background music. (The music file should be in the same folder.)

To control while enjoying musics or videos:

- Select or press ▶/|| button to play the file.
- Select or press ▶/|| button to pause the playing file.
- Select to play fast backward.
FB2X / FB4X / FB8X / FB16X / FB32 (Only for video)
- Select button to play fast forward.
FF2X / FF4X / FF8X / FF16X / FF32 (Only for video)
- Select or press I◀◀ button to go to previous file. For playing musics, press ◀ button also can go to previous song.
- Select or press ▶▶▶ button to go to next file. For playing musics, press ▶ button also can go to next song.

- Select  or press  button to stop the playing file.
- Select  or press **Display** button to show the playing file's information.
- Select  to repeat files in the folder.
R_None / R_One / R_All
- Select  to mute while playing the music file.
- Press **Wide** button to choose the display aspect ratio while playing the video file.
4:3 / 16:9 / Auto

Data Format for USB

Supported file system	FAT16/32
Max. folder layer	9
PHOTO mode	
Data format	JPEG, JPG, JPE
Max. number of photos	1200
Min. image resolution	128 × 128 pixels
Max. image resolution (Progressive DCT)	1,024 × 768 pixels
Max. image resolution (Baseline Sequential DCT)	15,360 × 8,640 pixels
MUSIC mode	
Data format	MP3
Bit rate	32Kbps ~ 448Kbps
MOVIE mode	
Data format	MPG, MPEG, MPEG2-TS, MPEG2-PS, MP4, MKV, AVI, Motion JPEG

CAUTION:

- Only supports USB Mass storage class devices.
- A JPEG image modified with PC may not be displayed.
- Partly degraded files might be displayed at a reduced resolution.
- Not guaranteed to support all USB devices.
- Do not use a USB Hub.
- Do not support multi-partition USB.

NOTE:

- The folder and file names may be different depending on the digital camera used.
- Support USB 2.0 Type A connector (DC5V, max. 500mA). For USB device over 500mA, we suggest to use adaptor or external power.

Maintenance and Recycling

Care Of The Screen

Do not rub or strike the screen with anything hard as this may scratch, mar, or even damage the screen permanently. Unplug the power cord before cleaning the screen. Dust the TV by wiping the screen and the cabinet with a soft, clean cloth. If the screen requires additional cleaning, use a clean, damp cloth. Do not use liquid cleaners, aerosol cleaners, or solvents of any kind.

Mobile Telephone Warning

Keep your mobile telephone away from your TV to avoid disturbances in the picture or sound, possibly causing permanent damage to your TV.

End Of Life Directives

In an effort to produce environmentally friendly products, your new TV contains materials that can be recycled and reused. At the end of your TV's life, specialized companies can minimize display waste by separating the reusable materials from non-reusable materials. Please ensure you dispose of your TV according to local regulations.

Manufacturer's Recycling and Energy Information

NEC DISPLAY SOLUTIONS is strongly committed to environmental protection and sees recycling as one of the company's top priorities in trying to minimize the burden placed on the environment. We are engaged in developing environmentally-friendly products, and always strive to help define and comply with the latest independent standards from agencies such as ISO (International Organisation for Standardization) and TCO (Swedish Trades Union).

Disposing of your old NEC product

The aim of recycling is to gain an environmental benefit by means of re-use, upgrading, reconditioning or reclamation of material. Dedicated recycling sites ensure that environmentally harmful components are properly handled and securely disposed. To ensure the best recycling of our products, **NEC DISPLAY SOLUTIONS offers a variety of recycling procedures** and gives advice on how to handle the product in an environmentally sensitive way, once it has reached the end of its life.

All required information concerning the disposal of the product and country-specific information on recycling facilities can be found on our following websites:

<http://www.nec-display-solutions.com/greencompany/> (in Europe),

<http://www.nec-display.com> (in Japan) or

<http://www.necdisplay.com> (in USA).

Energy Saving

This TV features an advanced energy saving capability. When a VESA Display Power Management Signalling (DPMS) Standard signal is sent to the TV, the Energy Saving mode is activated. The TV enters a single Energy Saving mode.

Mode	Power consumption	LED color
On Mode (with USB, with Audio)	Approx. 248 W (E655) Approx. 143 W (E585) Approx. 122 W (E505) Approx. 99 W (E425) Approx. 53 W (E325)	None
Standby Mode	Less than 0.5 W	Red

Product Specification

This model complies with the specifications listed below.
 Reorient or relocate the receiving display.
 Designs and specifications are subject to change without notice.
 This model may not be compatible with features and/or specifications that may be added in the future.

Model Name		E655	E585
DISPLAY			
Viewable		65"	58"
Resolution		1,920 × 1,080	
Color		Over 16 million colors (depending on video card used)	
Frequency	Horizontal:	31 – 83 KHz (Analog input) 15.625/15.734KHz, 31 - 83KHz (HDMI input)	
	Vertical:	60 – 75 Hz (Analog input) 24Hz, 30Hz, 50Hz, 60Hz - 75Hz (HDMI input)	
Pixel Clock		25 – 156 MHz	
Television System		NTSC Standard, ATSC Standard (8-VSB, Clear-QAM)	
Channel Coverage		VHF: 2 through 13 UHF: 14 through 69 Cable TV: Mild band (A - 8 through A - 1, A through I), Super band (J through W), Hyper band (AA through ZZ, AAA, BBB), Ultra band (65 through 94, 100 through 125)	
CONNECTIONS (Downward)			
SPDIF OUT		PCM, Fibre optic	
COMPONENT / AV IN	AV (shared with component Y)	RCA PIN Type 1.0 V[p-p] / 75 ohm	
	AUDIO L / R	RCA PIN Type 0.5Vrms	
	Y Pb/Cb, Pr/Cr	Y: 1.0 V [p-p] Pb/Cb, Pr/Cr: 0.7V p-p 75 ohm	
ANT / CABLE		VHF/UHF	
PC IN	VGA	Analog RGB (D-sub15 pin)	
	AUDIO	Stereo mini jack	
CONNECTIONS (Side)			
RS-232C		9 Pin D-sub	
HDMI 1 / 2 / 3		Type A Connectors	
USB		USB2.0 DC 5V, Max. 500mA	

Model Name	E655	E585
WEIGHT & DIMENSION		
Dimensions w/ Stand and Base (W × H × D) (inch)	57.77 × 36.38 × 14.17	51.24 × 31.46 × 13.75
Dimensions w/o Stand and Base (W × H × D) (inch)	57.77 × 34.34 × 3.94	51.27 × 29.89 × 4.29
Weight w/ Stand and Base (lbs)	77.1 lbs	48.4 lbs
Weight w/o Stand and Base (lbs)	66.3 lbs	46.64 lbs
WALL MOUNTING		
VESA-compatible wall bracket (W × H)	400 × 400 mm	400 × 400 mm
Screw type	Metric 6	Metric 6
POWER		
Power Consumption	248 W	143 W
Standby	< 0.5 W	
Current Rating	2.1 A @ AC 120V, 60Hz	1.2 A @ AC 120V, 60Hz
AUDIO		
Speaker Output	10 W + 10 W (16 ohm)	10 W + 10 W (8 ohm)
Analog Audio	Stereo L/R 0.5Vrms	
Digital Audio	PCM / Dolby Digital, Fibre optic	
OPERATING ENVIRONMENT		
Temperature	0°C – 40°C / 32°F – 104°F	
Humidity	10% – 80%	
Height	0 – 2,000m	
STORAGE ENVIRONMENT		
Temperature	-10°C – 60°C / 14°F – 140°F	
Relative Humidity	5% – 85%	
Absolute Air Humidity	1–25 g/m ³	
Max. Change of Temp.	0.5°C/min (max. 10°C / 30min)	
Air Pressure	795 – 1,060 mbar (79.5–106Kpa)	
Radiation Solar Heat	700 W/m ²	

Model Name	E655	E585
PACKAGE CONTENTS		
Supplied Accessories	Monitor (1) Remote control (1) 1.5 V AAA batteries (2) Power cord (1) D-sub cable (1) User's manual (1)	

All specifications, weights, and dimensions are subject to change without prior notice. Please access www.necdisplay.com for detailed specifications and dimensions for custom installations.

NOTE:

Model Name	E655	E585
TV Base stand Screw	X	X
Neck Screw	X	X
VESA Hole Depth	M6 (30mm)	M6 (22mm)

Model Name		E505	E425	E325
DISPLAY				
Viewable		50"	42"	32"
Resolution		1,920 × 1,080		1,366 × 768
Color		Over 16 million colors (depending on video card used)		
Frequency	Horizontal:	31 – 83 KHz (Analog input) 15.625/15.734KHz, 31 - 83KHz (HDMI input)		
	Vertical:	60 – 75 Hz (Analog input) 24Hz, 30Hz, 50Hz, 60Hz - 75Hz (HDMI input)		
Pixel Clock		25 – 156 MHz		
Channel Coverage		VHF: 2 through 13 UHF: 14 through 69 Cable TV: Mild band (A - 8 through A - 1, A through I), Super band (J through W), Hyper band (AA through ZZ, AAA, BBB), Ultra band (65 through 94, 100 through 125)		
CONNECTIONS (Downward)				
SPDIF OUT		PCM, Fibre optic		
COMPONENT / AV IN	AV (shared with component Y)	RCA PIN Type 1.0 V [p-p] / 75 ohm		
	AUDIO L / R	RCA PIN Type 0.5Vrms		
	Y Pb/Cb, Pr/Cr	Y: 1.0 V [p-p] Pb/Cb, Pr/Cr: 0.7V p-p 75 ohm		
ANT / CABLE		VHF / UHF		
PC IN	VGA	Analog RGB (D-sub15 pin)		
	AUDIO	Stereo mini jack		
CONNECTIONS (Side)				
RS-232C		9 Pin D-sub		
HDMI 1 / 2 / 3		Type A Connectors		
USB		USB2.0 DC 5V, Max. 500mA		

Model Name	E505	E425	E325
WEIGHT & DIMENSION			
Dimensions w/ Stand and Base (W × H × D) (inch)	44.25 × 26.93 × 10.04	37.80 × 23.30 × 10.04	28.62 × 18.16 × 10.04
Dimensions w/o Stand and Base (W × H × D) (inch)	44.25 × 25.47 × 3.03	37.80 × 21.87 × 3.02	28.62 × 16.71 × 3.02
Weight w/ Stand and Base (lbs)	29.8 lbs	18.7 lbs	11.73 lbs
Weight w/o Stand and Base (lbs)	28.7 lbs	17.6 lbs	10.65 lbs
WALL MOUNTING			
VESA-compatible wall bracket (W × H)	400 × 200 mm	200 × 200 mm	100 × 100 mm
Screw type	Metric 6	Metric 4	Metric 4
POWER			
Power Consumption	122 W	99 W	53 W
Standby	< 0.5 W		
Current Rating	1.1 A @ AC 120V, 60Hz	0.9 A @ AC 120V, 60Hz	0.8 A @ AC 120V, 60Hz
AUDIO			
Speaker Output	10 W + 10 W (8 ohm)	10 W + 10 W (8 ohm)	5 W + 5 W (8ohm)
Analog Audio	Stereo L/R 0.5Vrms		
Digital Audio	PCM / Dolby Digital, Fibre optic		
OPERATING ENVIRONMENT			
Temperature	0°C – 40°C / 32°F – 104°F		
Humidity	10% – 80%		
Height	0 – 2,000m		
STORAGE ENVIRONMENT			
Temperature	-10°C – 60°C / 14°F – 140°F		
Relative Humidity	5% – 85%		
Absolute Air Humidity	1–25 g/m ³		
Max. Change of Temp.	0.5°C/min (max. 10°C / 30min)		
Air Pressure	795 – 1,060 mbar (79.5–106Kpa)		
Radiation Solar Heat	700 W/m ²		

Model Name	E505	E425	E325
PACKAGE CONTENTS			
Supplied Accessories	Monitor (1) Remote control (1) 1.5 V AAA batteries (2) Power cord (1) D-sub cable (1) User's manual (1)		

All specifications, weights, and dimensions are subject to change without prior notice. Please access www.necdisplay.com for detailed specifications and dimensions for custom installations.

NOTE:

Model Name	E505	E425	E325
TV Base stand Screw	X	X	X
Neck Screw	X	X	X
VESA Hole Depth	M6 (15mm)	M4 (15mm)	M4 (12.5mm)

RS-232C Port Specifications

PC control of the TV

Attach an RS-232C cable cross-type (commercially available) to the supplied RS-232C for the connections.

NOTE:

This operation system should be used by a person who is accustomed to using computers.

Communication procedure

Send the control commands from the PC via the RS-232C connector.

The TV operates according to the received command and sends a response message to the PC.

Do not send multiple commands at the same time. Wait until the PC receives the response before sending the next command.

Interface

Protocol	RS-232C
Baud rate	9,600 bps
Data length	8 bits
Parity bit	None
Stop bit	1 bit
Communication code	ASCII

This LCD TV uses RXD, TXD and GND lines for RS-232C control.

The reverse type cable (null modem cable) (not include) should be used for RS-232C control.

Control command diagram

Function (Monitor ID = 1)	Code Data
Power ON	01 30 41 30 41 30 43 02 43 32 30 33 44 36 30 30 30 31 03 73 0d
Power OFF	01 30 41 30 41 30 43 02 43 32 30 33 44 36 30 30 30 34 03 76 0d
Input Source Select VGA	01 30 41 30 45 30 41 02 30 30 36 30 30 30 31 03 73 0d
Input Source Select HDMI	01 30 41 30 45 30 41 02 30 30 36 30 30 30 31 03 72 0d
Input Source Select Component	01 30 41 30 45 30 41 02 30 30 36 30 30 30 43 03 01 0d
Input Source Select Composite	01 30 41 30 45 30 41 02 30 30 36 30 30 30 35 03 77 0d
Sound Mute ON	01 30 41 30 45 30 41 02 30 30 38 44 30 30 30 31 03 09 0d
Sound Mute OFF	01 30 41 30 45 30 41 02 30 30 38 44 30 30 30 32 03 0a 0d

Before Calling Service

Please make these simple checks before calling service. These tips may save you time and money as charges for receiver installation and adjustments of customer controls are not covered under your warranty.

Symptoms	Items To Check And Actions To Follow
"Ghost " or double image when using the tuner	<ul style="list-style-type: none"> This may be caused by an obstruction to the antenna due to high rise buildings or hills. Using a highly directional antenna may improve the picture.
No power	<ul style="list-style-type: none"> Check to see if the TV's AC power cord is plugged into the outlet. Unplug the TV and after 60 seconds reinsert the plug into the outlet and power on the TV.
No picture	<ul style="list-style-type: none"> At the rear of the TV make sure the antenna connection is properly attached. Check to see if there is a station broadcast problem by trying multiple channels. Adjust the contrast and brightness settings. Check the Closed Caption settings as some text modes may block the visibility of the images on the TV.
Good picture but no sound	<ul style="list-style-type: none"> Increase the volume. Confirm that the TV is not muted by pressing the Mute button on the remote control.
Good sound but poor color	<ul style="list-style-type: none"> Adjust the contrast, color and brightness settings.
Poor picture	<ul style="list-style-type: none"> Poor picture quality may occur when an activated S-VHS camera or camcorder is connected to your TV and another peripheral at the same time. Switch off one of the peripherals.
Snowy picture and noise when using the tuner	<ul style="list-style-type: none"> Check the antenna connection and signal.
Presence of a horizontal dotted line	<ul style="list-style-type: none"> This may be caused by electrical interference (e.g. hairdryer, nearby neon lights, etc.). Power cycle the equipment by turning off and then turning back on.
TV not responding via the remote control	<ul style="list-style-type: none"> Determine if the batteries are working and replace batteries if necessary. Clean the remote control sensor lens on the TV. If necessary, utilize the buttons located on the side of the TV. Select the TV mode to ensure your remote control is set in the TV mode.

Glossary

HDTV

HDTV displays are technically defined as being capable of displaying a minimum of 720p or 1080i active scan lines.

HDMI Inputs

High-Definition Multimedia Interface Audio / Video Inputs are located on the receiver. These connectors are used for the input of audio and video signals. Designed to receive higher picture resolution and offer sound connection options.

Menu

An on-screen listing of features shown on the TV screen is made available for user adjustments.

RF

Radio Frequency or modulated signal design used by the carrier for television broadcasts.

Second Audio Program (SAP)

Another or additional audio channel provided for in the Multichannel Television Sound (MTS) broadcast standard. A monaural soundtrack included within the recorded or video signal (usually containing a second language translation for the displayed program).

Sleep Timer

You can set a time period for which the TV will automatically turn off.

Limited Warranty

NEC Display Solutions of America, Inc. (hereinafter “NEC DISPLAY SOLUTIONS”) warrants this Product to be free from defects in material and workmanship and, subject to the conditions set forth below, agrees to repair or replace (at NEC DISPLAY SOLUTIONS’ sole option) any part of the enclosed unit which proves defective for a period of three (3) years from the date of first consumer purchase. Spare parts are warranted for ninety (90) days, Replacement parts of unit may be new or refurbished and will meet specifications of the original parts or unit. This warranty gives you specific legal rights and you may also have other rights, which vary from state to state, this warranty is limited to the original purchaser of the Product and is not transferable.

This warranty covers only NEC DISPLAY SOLUTIONS supplied components. Service required as a result of third party components is not covered under this warranty. In order to be covered under this warranty, the Product must have been purchased in the U.S.A. or Canada by the original purchaser. This warranty only covers Product distribution in the U.S.A. or Canada by NEC DISPLAY SOLUTIONS. No warranty service is provided outside of the U.S.A. or Canada, Proof of Purchase will be required by NEC DISPLAY SOLUTIONS to substantiate date of purchase. Such proof of purchase must be an original bill of sale or receipt containing name and address of seller, purchaser, and the serial number of the product.

It shall be your obligation and expense to have the Product shipped, freight prepaid, or delivered to the authorized reseller from whom it was purchased or other facility authorized by NEC DISPLAY SOLUTIONS to render the services provided hereunder in either the original package or a similar package affording an equal degree of protection. All Products returned to NEC DISPLAY SOLUTIONS for service MUST have prior approval, which may be obtained by calling 1-800-632-4662. The Product shall not have been previously altered, repaired, or serviced by anyone other than a service facility authorized by NEC DISPLAY SOLUTIONS to render such service. The serial number of the product shall not have been altered or removed. In order to be covered by this warranty the Product shall not have been subjected to displaying of fixed images for long periods of time resulting in image persistence (afterimage effects), accident, misuse or abuse or operated contrary to the instructions contained in the User’s Manual. Any such conditions will void this warranty.

NEC DISPLAY SOLUTIONS SHALL NOT BE LIABLE FOR DIRECT, INDIRECT, INCIDENTAL, CONSEQUENTIAL, OR OTHER TYPES OF DAMAGES RESULTING FROM THE USE OF ANY NEC DISPLAY SOLUTIONS PRODUCT OTHER THAN THE LIABILITY STATED ABOVE. THESE WARRANTIES ARE IN LIEU OF ALL OTHER WARRANTIES EXPRESS OR IMPLIED, INCLUDING, BUT NOT LIMITED TO, THE IMPLIED WARRANTIES OF MERCHANTABILITY OR FITNESS FOR A PARTICULAR PURPOSE. SOME STATES DO NOT ALLOW THE EXCLUSION OF IMPLIED WARRANTIES OR THE LIMITATION OR EXCLUSION OF LIABILITY FOR INCIDENTAL OR WARRANTIES OR THE LIMITATION OR EXCLUSION OF LIABILITY FOR INCIDENTAL OR CONSEQUENTIAL DAMAGES SO THE ABOVE EXCLUSIONS OR LIMITATIONS MAY NOT APPLY TO YOU.

This Product is warranted in accordance with the terms of this limited warranty. Consumers are cautioned that Product performance is affected by system configuration, software, the application, customer data, and operator control of the system, among other factors. While NEC DISPLAY SOLUTIONS Products are considered to be compatible with many systems, specific functional implementation by the customers of the Product may vary. Therefore, suitability of a Product for a specific purpose or application must be determined by consumer and is not warranted by NEC DISPLAY SOLUTIONS.

For the name of your nearest authorized NEC Display Solutions of America, Inc. service facility, contact NEC Display Solutions of America, Inc. at 1-800-632-4662.

References

NEC Monitor Customer Service & Support

Customer Service and Technical Support

Parts and Accessories

(800) 632-4662 (888) 634-4662

Fax (800) 695-3044

Warranty Information

www.necdisplay.com

Online Technical Support

www.necdisplay.com

Sales and Product Information

Sales information Line

(888) 632-6487

Canadian Customers

(866) 771-0266, Ext#: 4037

Government Sales

(800) 284-6320

Government Sales email

gov@necdisplay.com

Electronic Channels

<http://www.necdisplay.com>

Product Registration

<http://www.necdisplay.com>

Drivers and Downloads

<http://www.necdisplay.com>