

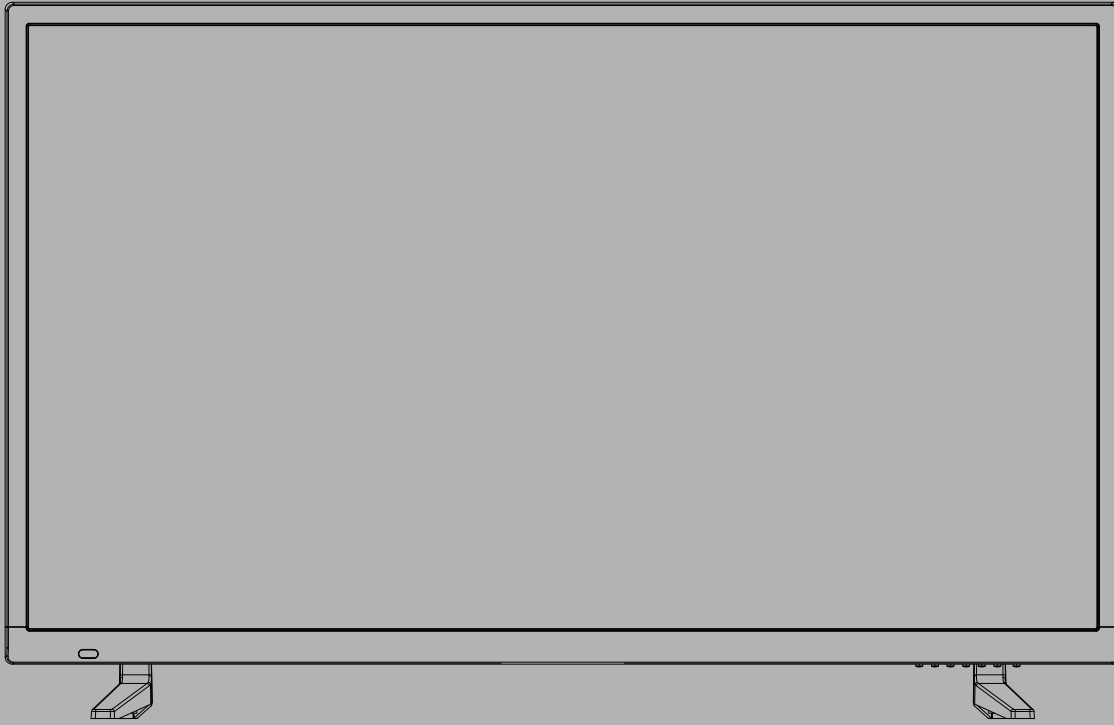



40EQX10



USER'S MANUAL  
**40" 4K ULTRA HD TELEVISION**

# Important Safety Instructions

1. Read these instructions.
2. Keep these instructions.
3. Heed all warnings.
4. Follow all instructions.
5. Do not use this apparatus near water.
6. Clean only with dry cloth.
7. Do not block any ventilation openings. Install in accordance with the manufacturer's instructions.
8. Do not install near any heat sources such as radiators, heat registers, stoves, or other apparatus (including amplifiers) that produce heat.
9. Do not defeat the safety purpose of the polarized or grounding-type plug. A polarized plug has two blades with one wider than the other. A grounding type plug has two blades and a third grounding prong. The wide blade or the third prong are provided for your safety. If the provided plug does not fit into your outlet, consult an electrician for replacement of the obsolete outlet.
10. Protect the power cord from being walked on or pinched particularly at plugs, convenience receptacles, and the point where they exit from the apparatus.
11. Only use attachments / accessories specified by the manufacturer.
12. Use only with the cart, stand, tripod, bracket, or table specified by the manufacturer, or sold with the apparatus. When a cart is used, use caution when moving the cart / apparatus combination to avoid injury from tip-over.
13. Unplug this apparatus during lightning storms or when unused for long periods of time. 
14. Refer all servicing to qualified service personnel. Servicing is required when the apparatus has been damaged in any way, such as power-supply cord or plug is damaged, liquid has been spilled or objects have fallen into the apparatus, the apparatus has been exposed to rain or moisture, does not operate normally, or has been dropped.
15. **WARNING:** To Reduce The Risk Of Fire Or Electric Shock, Do Not Expose This Apparatus To Rain Or Moisture.
16. Apparatus shall not be exposed to dripping or splashing and no objects filled with liquids, such as vases, shall be placed on the apparatus.
17. The mains plug or appliance coupler shall remain readily operable.
18. **Use in outdoors:** This TV is not designed for outdoors installation. Do not expose the TV to rain, as it may result in a fire or an electric shock. Also, do not expose the TV to direct sunlight, as it may heat up and become damaged.

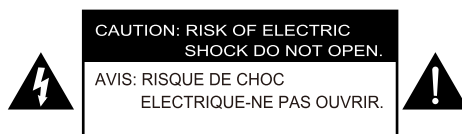

## Safety:

TO REDUCE THE RISK OF ELECTRICAL SHOCK DO NOT REMOVE COVER (OR BACK). NO USER SERVICEABLE PARTS ARE INSIDE. REFER TO QUALIFIED SERVICE TECHNICIAN ONLY.



Dangerous Voltage: The lightning flash with arrowhead symbol, within an equilateral triangle, is intended to alert the user to the presence of uninsulated "dangerous voltage" within the product's enclosure that may be of sufficient magnitude to constitute a risk of electric shock to the users.



Instruction: The exclamation point within an equilateral triangle is intended to alert the user to the presence of important operating and servicing instructions in the literature accompanying the appliance.

# Safety Instructions

Please read these instructions carefully.

This product complies with all applicable US federal safety requirements, as well as those of the Canadian Standards Association.

## **1. Cleaning**

Always unplug the TV before cleaning. Do not use liquid or aerosol cleaners. Use a soft, slightly damp cloth to clean.

## **2. Water and Moisture**

Do not use this TV near water. Avoid using this TV in an excessively damp environment.

## **3. Stand**

This TV should always be placed on a solid, sturdy surface.

## **4. Ventilation**

To prevent overheating, do not block or obstruct the vent openings on the TV's back panel. Also, avoid placing this TV in a confined area with poor air flow.

## **5. Power Sources**

This TV should be operated only from the type of power source indicated on the marking label. If you are not sure of the type of power supply to your home, consult your electronics retailer or local power company.

## **6. Power Cord Polarization**

This TV is equipped with a three-wire grounding type plug, a plug with a third (grounding) pin. As a safety feature, this plug will only fit into a grounded power outlet. If you are unable to insert the plug into the outlet, contact your electrician to replace the obsolete outlet. Do not defeat the safety purpose of the grounding-type plug.

## **7. Power Cord Protection**

Power-supply cords should be routed so that they are not likely to be walked on or pinched by items placed upon or against them. Pay particular attention to cords at plugs, convenience receptacles, and the point where they exit from the TV.

## **8. Lightning**

To protect the TV during a lightning storm, or when it is left unattended and unused for long periods of time, unplug it from the wall outlet and disconnect the antenna or cable system. This will prevent damage to the TV from lightning and power-line surges.

# Safety Instructions

## 9. Outdoor Antenna Grounding

If an outside antenna or cable system is connected to the TV be sure the antenna or cable system is grounded so as to provide some protection against voltage surges and built up static charges. Article 810 of the National Electrical Code (U.S. A.), ANSI / NFPA 70 provides information with regard to proper grounding of the mast and supporting structure, grounding of the lead-in wire to an antenna discharge unit, size of grounding conductors, location of antenna-discharge unit, connection to grounding electrodes, and requirements for the grounding electrode.

*Example of Grounding According to National Electrical Code Instructions*

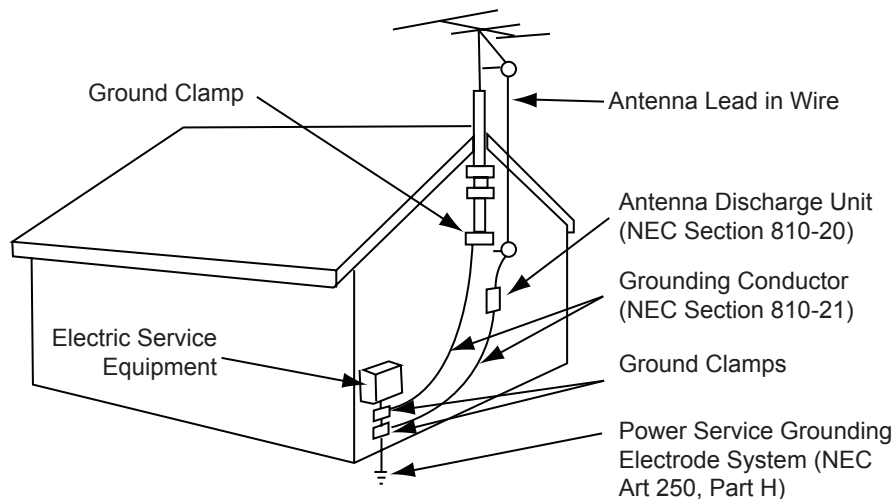

NEC - National Electrical Code

## 10. Power Lines

An outside antenna system should not be located in the vicinity of overhead power lines or other electric light or power circuits, or where it can fall on to power lines or circuits. When installing an outside antenna system, extreme care should be taken to keep from touching such power lines or circuits as contact with them might be fatal.

## 11. Overloading

Do not overload wall outlets and extension cords as this can result in a risk of fire or electric shock.

## 12. Object and Liquid Entry

Never push objects of any kind into this TV through openings as they may touch dangerous voltage points or short-out parts that could result in a fire or electric shock. Never spill liquid of any kind on or inside the TV.

## 13. Servicing

Do not attempt to service this TV yourself as opening or removing covers may expose you to dangerous voltage or other hazards. Refer all servicing to a qualified service technician.

## 14. Damage Requiring Service

Unplug from the wall outlet and refer servicing to a qualified service technician under the following conditions:

- If the power-supply cord or plug is damaged.
- If liquid has been spilled, or objects have fallen into the product.
- If the TV has been exposed to rain or water.
- If the TV does not operate normally by following the operating instructions. Adjust only those controls that are covered by the operating instructions as an improper adjustment of other controls may result in damage and will often require extensive work by a qualified technician to restore the product to its normal operation.
- If the TV has been dropped or the cabinet has been damaged.
- If the TV exhibits a distinct change in performance.

# Safety Instructions

## 15. Replacement Parts

When replacement parts are required, be sure that only an authorized service technician has used replacement parts specified by the manufacturer or have the same characteristics as the original part. Unauthorized substitutions may result in fire, electric shock, or other hazards and void any warranty.

## 16. Safety Check

Upon completion of any service or repairs to this TV, ask the service technician to perform safety checks to determine whether the product is in proper operating condition.

## 17. Wall Mounting

The TV should be mounted to a wall only by a professional. The TV may slide or fall, causing serious injury to a child or adult, and serious damage to the product. Warranty shall be voided.

## 18. Heat

The TV should be situated away from heat sources such as radiators, heat registers, stoves, or other products (including amplifiers) that produce heat.

## NOTE TO CABLE / TV INSTALLER:

This reminder is provided to call the CATV system installer's attention to Article 820-40 of the National Electric Code (USA). The code provides guidelines for proper grounding and, in particular, specifies that the cable ground should be connected to the grounding system of the building, as close to the point of the cable entry as practical.

## FCC REGULATORY INFORMATION:

This television has been tested and found to comply with the limits for a Class B digital device, pursuant to Part 15 of the FCC Rules. These limits are designed to provide reasonable protection against harmful interference in a residential installation. This television generates, uses and can radiate radio frequency energy and, if not installed and used in accordance with the instructions, may cause harmful interference to radio communications. However, there is no guarantee that interference will not occur in a particular installation. If this television does cause interference to other electronic equipment, which can be determined by turning the television off and on, then the user is encouraged to try to correct the interference by one or more of the following measures:

- Reorient or relocate the receiving antenna.
- Increase the separation between the equipment and television.
- Connect the equipment into an outlet on a circuit different from that to which the television is connected.
- Consult your dealer or an experienced radio / TV technician for assistance.

Any changes or modifications not expressly approved by the party responsible for compliance may void the user's authority to operate the equipment.

## DISCLAIMERS

"HDMI", the HDMI Logo and High-Definition Multimedia Interface are trademarks or registered trademarks of HDMI Licensing LLC.

"Blu-ray Disc" is a trademark of Blu-ray Disc Association, registered in the U.S. and other countries.

MHL, Mobile High-Definition Link and the MHL Logo are trademarks or registered trademarks of the MHL, LLC.

All other trademarks are the property of their respective owners and are used for descriptive and/or compatibility purposes only.

# Table of Contents

Important Safety Instructions.....	1
Table of Contents .....	5
Introduction.....	6
Installing the Base .....	7
<b>Remote Control</b>	
Battery Install.....	8
Overview .....	9
<b>TV Overview</b>	
Front & Side Panel .....	11
Rear Panel .....	12
<b>Installation</b>	
Connect a digital cable box, satellite receiver, or DVD player with an HDMI cable .....	13
Connect a digital cable box, satellite receiver, or DVD player with a Component connection .....	14
Connect a digital cable box, satellite receiver, or DVD player with Composite cables (yellow, red, & white) .....	15
Connecting the Power and Basic Cable connection .....	16
Connection to a Home Theater System .....	17
<b>TV Setup</b>	
Initial Setup Wizard .....	18
<b>Picture Setting</b>	
Contrast.....	20
Brightness .....	20
Color.....	20
Tint.....	20
Sharpness .....	20
Color Temp .....	20
Advanced Settings .....	20
<b>Audio Settings</b>	
Bass .....	21
Treble .....	21
Balance .....	21
MTS.....	21
Digital Audio Output .....	21
Surround.....	21
AVL .....	21
Audio Language .....	21
<b>Date &amp; Time Settings</b> .....	22
<b>Setup Settings</b>	
Menu Languages.....	23
Transparent .....	23
OSD Timeout.....	23
<b>Closed Captions</b> .....	24
<b>CEC Settings</b> .....	25
<b>Parental Control</b> .....	26
<b>Channel Settings</b>	
Favorite .....	28
Show / Hide .....	28
Channel Label .....	28
TV Channel Setup & Channel Auto Scan.....	29
<b>Aspect Modes</b> .....	30
<b>USB Modes</b> .....	31
<b>MHL Setting</b> .....	32
<b>Specifications</b> .....	33
<b>Troubleshooting</b> .....	34

# Introduction

## What's In The Box

Please refer to this guide whenever you have questions about features and functions. This instruction book will get you up and running with the best possible connection type for your devices. Enjoy!

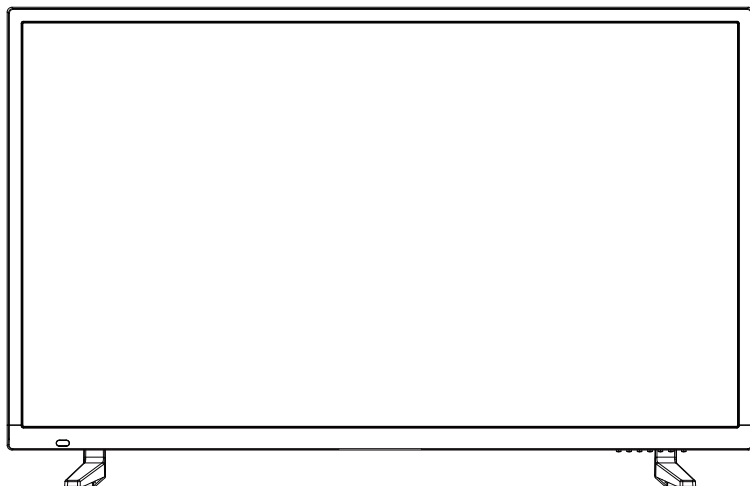

The package includes the following items. Save the carton & packing for future shipping

- **Remote Control**
- **AAA Batteries (2)**
- **Quick Start Guide**
- **User Manual**
- **Pedestal Base**
- **Screws for Pedestal Base (4)**



- Remote Control
- AAA Batteries x 2



- User manual
- Quick Start Guide

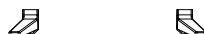

- Base Legs



- Screws for Base Legs

## Wall Mount Information

This TV uses a 200x200 VESA mounting bracket attachment pattern. Please take this information with you when purchasing a wall mount for this TV.

# Installing the Base

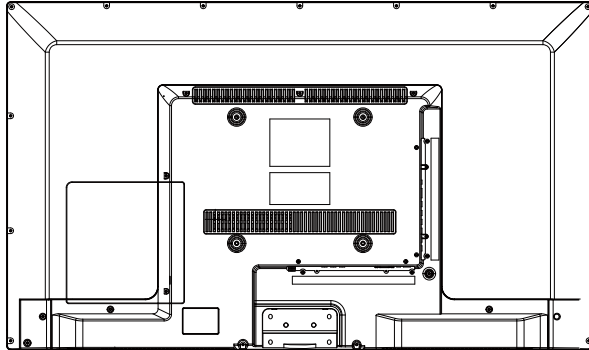

Place the TV face down on a soft cloth or cushion.

Position base as shown.



1

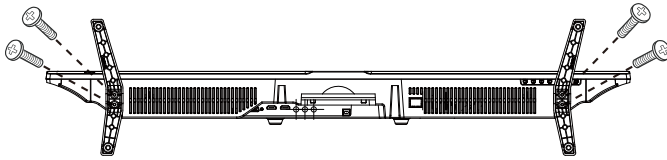

Insert 4 screws (provided) through the holes in the bottom of the base into the post holes and tighten securely. Do not over-tighten.



# Remote Control

## Battery Install

Your remote control handset is powered by two (2) AAA type batteries



- Turn the remote over and remove battery cover.



- Place two (2) "AAA" batteries into the battery compartment with the "+" and "-" ends facing as indicated.



- Replace the cover

- Effective remote range is approximately 16 feet at an angle of no greater than 30° to the left / right or 20° up / down to the IR sensor.
- To avoid possible damage from battery chemical leakage, remove the batteries if you do not plan to use the remote for an extended period of time. Do not mix batteries of different age and / or type. Always discard used batteries safely.
- Do not expose the remote control to liquids, direct sunlight or sources of excessive heat.
- The IR receiver on the TV will not work properly if the set is in direct sunlight.

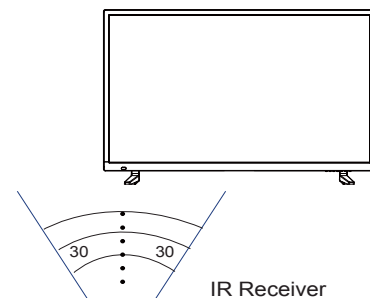

NOTE: Improper use of batteries can result in a chemical leakage or explosion.

### Cable / Satellite Remote Control Codes:

**NOTE:** The remote control from your Cable/Satellite provider can be programmed to operate most of the major functions of this TV model which include: **POWER, INPUT / SOURCE, VOLUME +, VOLUME - , CHANNEL +, CHANNEL - , SELECT/OK/ENTER** (based on your remote), and **NUMBER** buttons. For non-major TV functions not listed, use the remote control included with this TV.

To program your Cable / Satellite remote to operate this TV, follow the programming instructions included with your providers' remote and use the following codes.

Comcast or Direct TV : 10030

AT & T (U-verse) : 1043

Dish Network : 506

RCA Universal : 0030

# Remote Control

## Overview

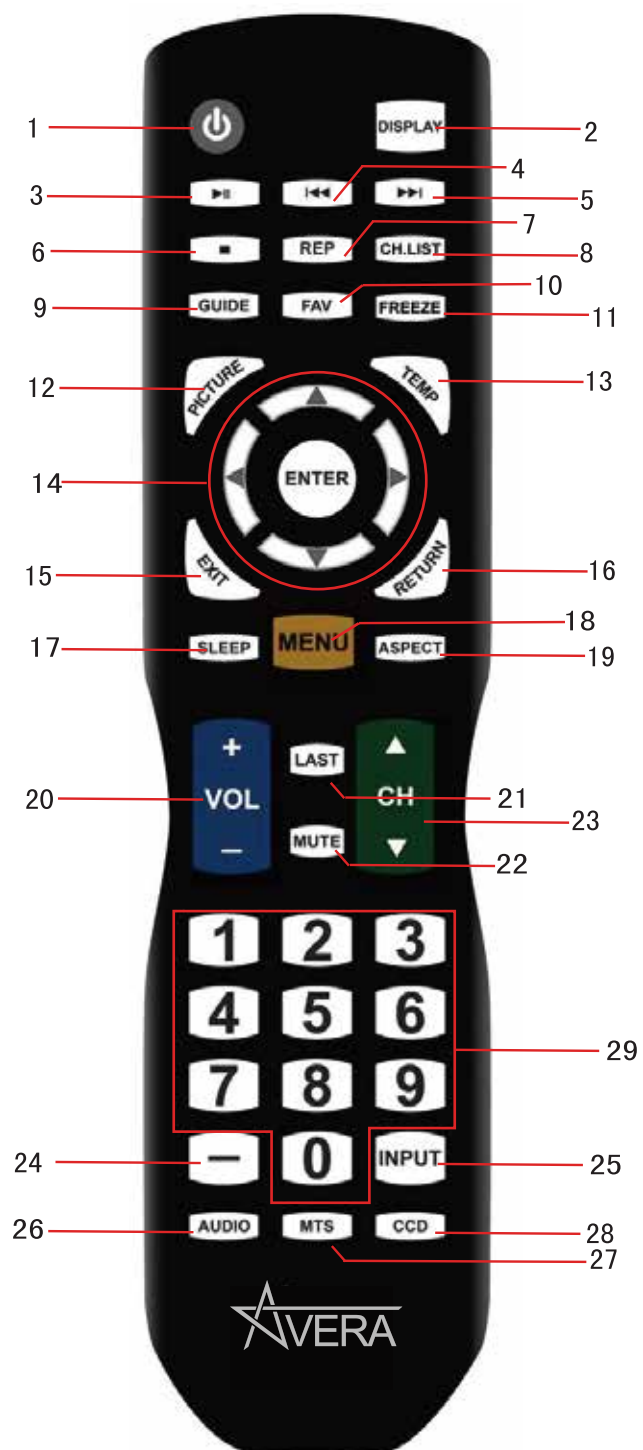

# Remote Control Overview

Button	Function
1. POWER	Turn the display ON or OFF (Standby).
2. DISPLAY	Provides program information for program being viewed.
3. ►	PLAY/PAUSE (USB)
4. ◀◀	PREVIOUS (USB)
5. ▶▶	NEXT (USB)
6. ■	STOP (USB)
7. REP	REPEAT (USB)
8. CH.LIST	Press to display a list of channels saved in the TV tuner memory.
9. GUIDE	Press to review scheduled programming for the currently viewed channel.
10. FAV	Press to display a listing of your favorite TV channels.
11. FREEZE	Pause and still-frame the current image on the display. Press again for live TV.
12. PICTURE	STANDARD - DYNAMIC - SOFT - USER - POWER SAVING.
13. TEMP	Select the Color Temperature COOL - NORMAL - WARM.
14. ▼▲◀▶ARROWS / ENTER	Press the navigation buttons for moving through the menu options. Press the ENTER button to select / confirm.
15. EXIT	Press to exit a displayed menu.
16. RETURN	Press to return to the previous menu.
17. SLEEP	Press to activate the Sleep function. The TV will automatically turn off after; 5 - 10 - 15 - 30 - 45 - 60 - 90 - 120 - 180 - 240(minutes) - OFF.
18. MENU	Press to display the Main menu.
19. ASPECT	Select the viewable display aspect options: NORMAL - WIDE - ZOOM - CINEMA.
20. VOLUME (+ / -)	Adjust the volume up (+) or the volume down (-).
21. LAST	Press to switch between the current channel and previously viewed channel.
22. MUTE	Press to temporarily turn off the TV audio. Press again to resume.
23. CHANNEL (▼▲)	Change the channel up or down.
24. NUMBERS / DASH	Select desired TV channel directly. For example: to select digital channel 4-1, press "4", press "-", and press "1" = (4-1).
25. INPUT	Press to display all of the input sources on screen.
26. AUDIO	STANDARD - MUSIC - MOVIE - USER
27. MTS	Press to select a program's second audio channel (if available).
28. CCD	Press to select closed caption subtitles (if available) OFF - ON - CC ON MUTE
29. NUMBER KEYS	Press number keys to enter channel numbers.

# TV Overview

## Front & Rear Panel

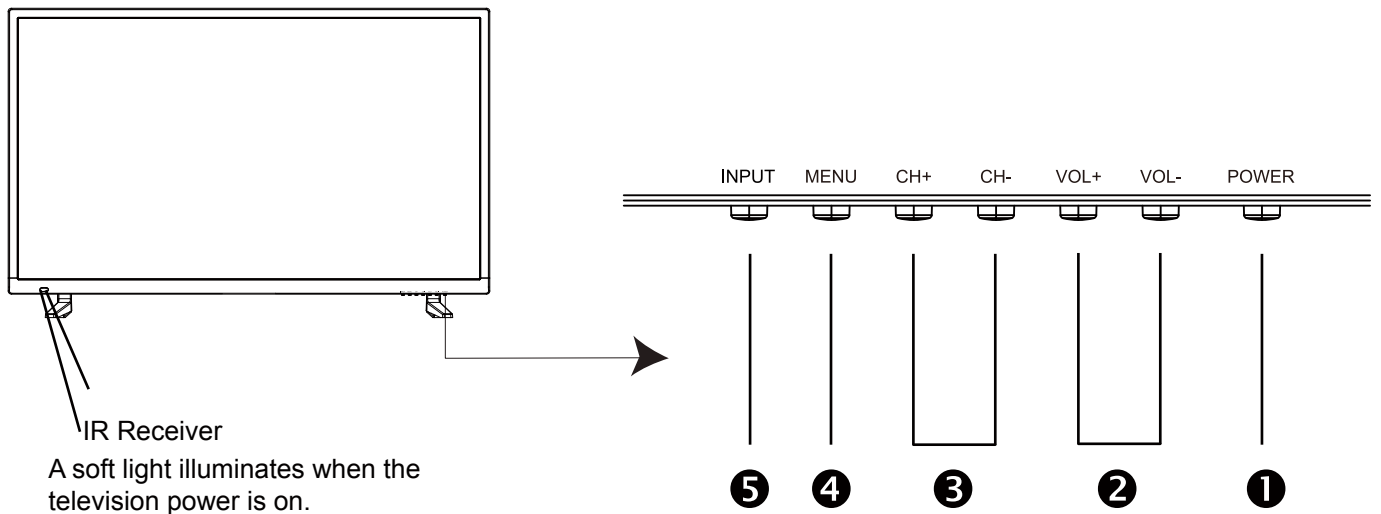

1. **POWER** - Press the **POWER** button to turn the TV ON/ OFF (power). The screen image will appear within a few seconds, and the LED will turn on.
2. **Volume (+VOL-)** - Press the **VOL+** / **VOL-** buttons to adjust the volume up or down.
3. **Channel (+CH-)** - Press the **CH+**/ **CH-** buttons to select a channel in the TV mode.
4. **MENU** - Press the **MENU** button to display. Press **VOL+** to select from the 6 menu options available. Press the **CH+** / **CH-** buttons to select a feature from the selected menu then press the **VOL+/VOL-** buttons to adjust the volume settings.
5. **INPUT** - After connecting your DVD, cable box, etc. select the appropriate input source to view. Press the **INPUT** button to display the input options. Press the **CH+** / **CH-** buttons to highlight the input source and press the **VOL+** button to select.

# TV Overview Rear Panel

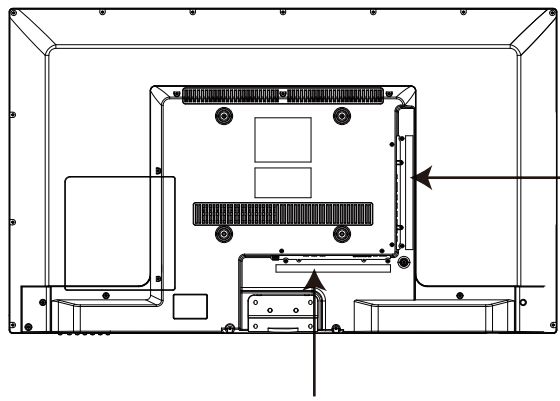

## Wall Mounting

It is recommended that you consult a professional before mounting this TV a wall.

Use VESA 200x200 wall mount hardware.

NOTE: You must remove the pedestal before wall mounting.

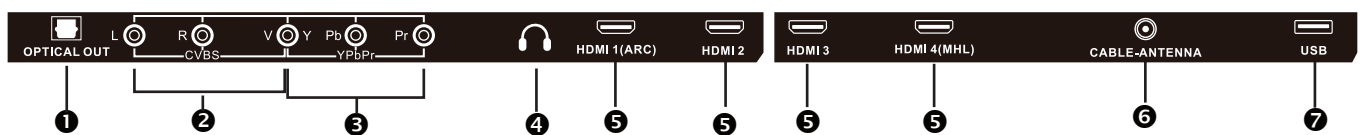

**1. OPTICAL OUT** - Connect to an AV Receiver for high quality digital audio.

**2. AV** - Connect an external device to the composite VIDEO (V) and AUDIO (L/R) out jacks found on most equipment.

**3. Component Y Pb Pr Input** - Connect to an AV device that features component (Y Pb Pr) video and audio output jacks.

**4. EARPHONE** - Connect a stereo headphone (3.5mm -not included) for private listening.

**5. HDMI1/2/3/4 IN** - To connect to a High Definition (HD) signal output device, such as a set top box, blu ray disc player or AV receiver.

Note: MHL compatible devices can be connected to HDMI 4 via a HDMI-to-MHL adapter (not included).

Note: HDMI 1 has ARC function.

**6. CABLE-ANTENNA** - Connect an antenna or cable connection for television reception.

Note: Use an outdoor antenna, cable or satellite for best reception.

**7. USB Input Port** - Connect to portable USB device such as USB flash/hard drive (max storage capacity 400GB, supports MP3 and JPEG).

# Installation

## Connection to HDMI Input

### Digital Cable / Satellite Set Top Box

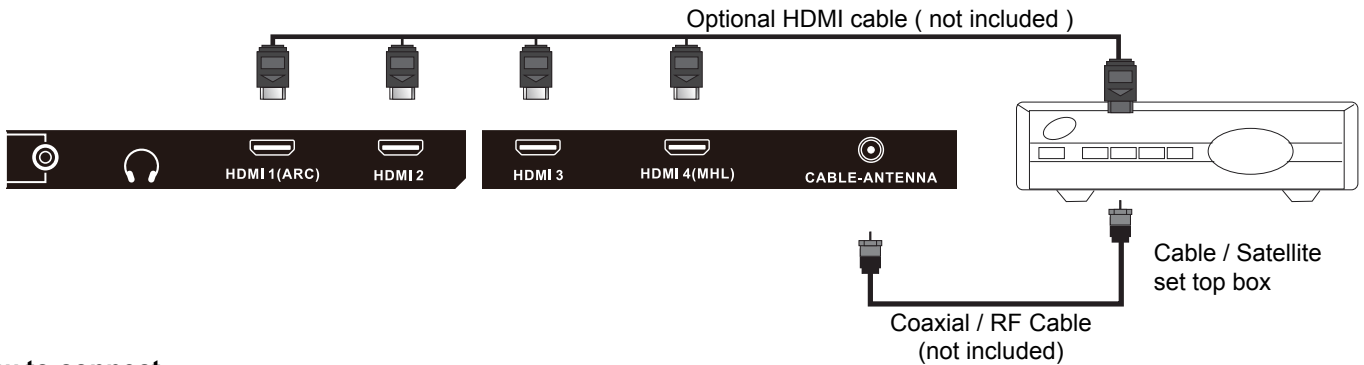

#### How to connect

- On the back of your device, connect the HDMI cable from HDMI out on device to HDMI in on the panel.

#### How to Use

- Press the **INPUT** button on the remote, then use the ▼▲ arrows to highlight **HDMI**. Press **ENTER**.

NOTE: You can also connect a digital cable/satellite box using an RF coaxial (75 ohm) cable. Most cable/satellite systems require the TV to be set to Ch. 3 or 4 to display a picture.

### Blu-ray, HD DVD, or Game Console

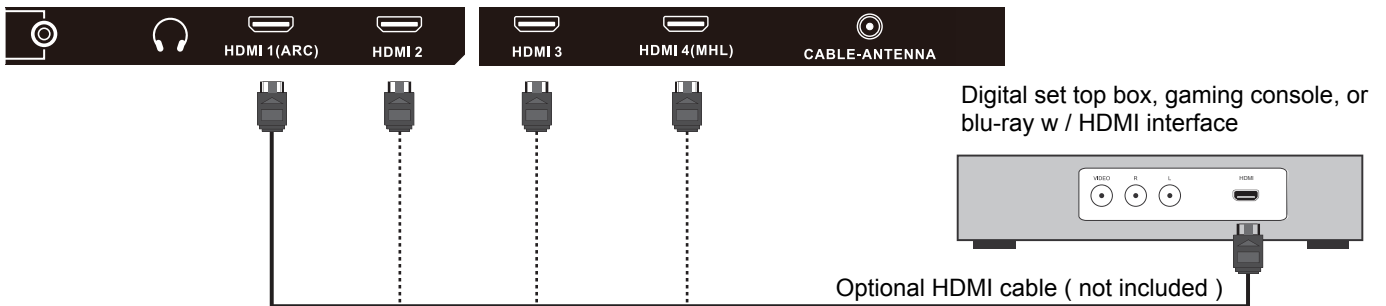

#### How to Connect

- On the back of your device, connect the HDMI cable from HDMI out on device to HDMI in on the panel.

#### How to Use

- Press the **INPUT** button on the remote, then use the ▼▲ arrows to highlight **HDMI**. Press **ENTER**.

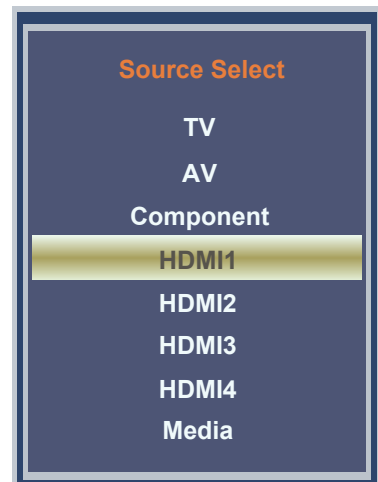

# Installation

## Connection to Component YPbPr Input

### Connecting a device with a Component connection.

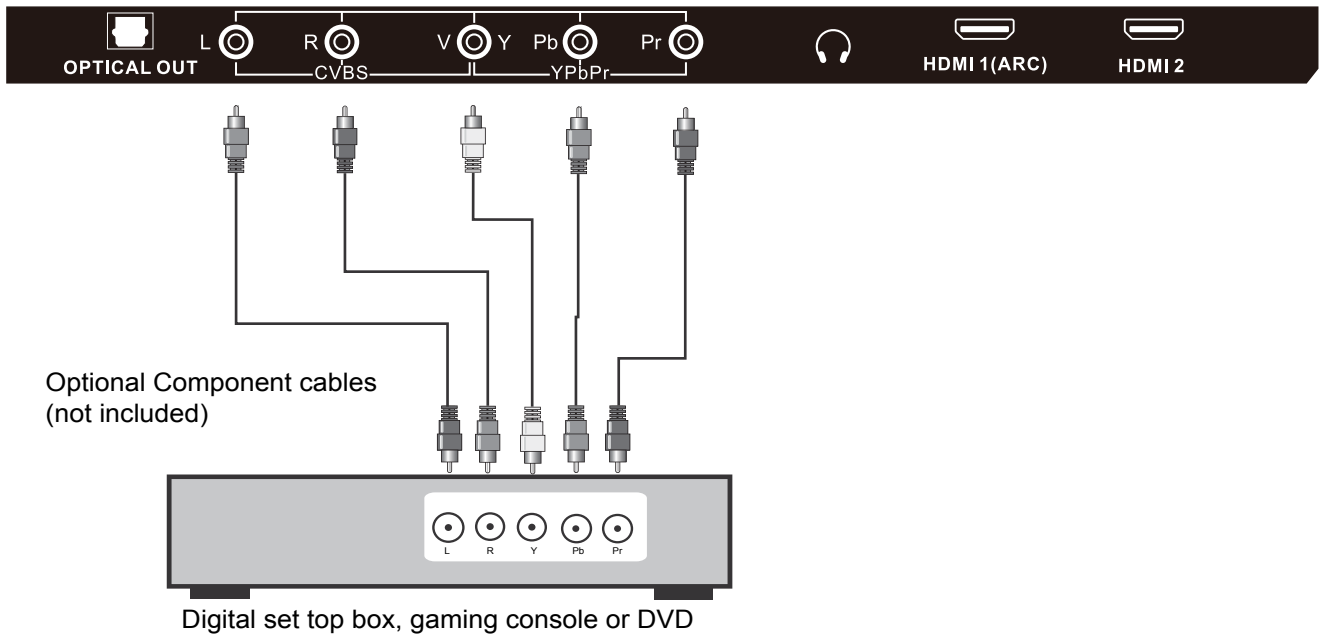

#### How to Connect

- Match and insert the green (Y), blue (Pb), and red (Pr) cables into the device and TV. Next, connect the red and white (L & R) audio cables.

\*NOTE: The picture will be black & white if hooked up incorrectly. You must hook up audio cables separately.

#### How to Use

- Press the **INPUT** button on the TV remote. Then use the ▼▲ arrow buttons to highlight **Component**. Press **ENTER**.



# Installation

## Connection to Composite Input

### Connecting a device with a Composite connection.

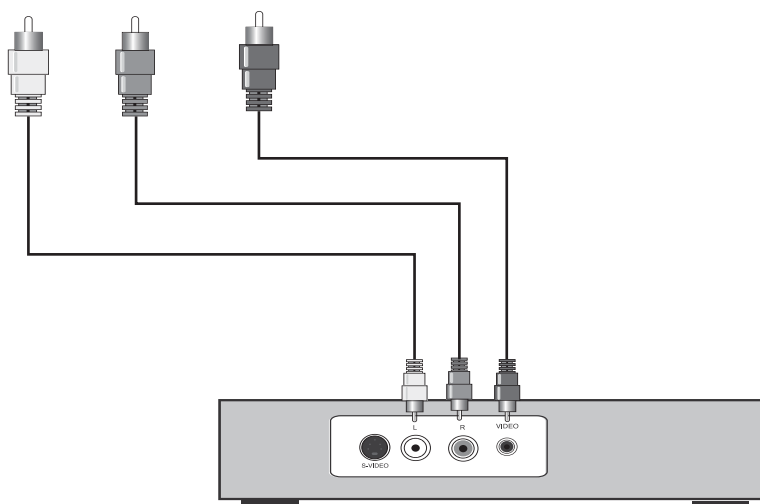

Digital set top box, gaming console or DVD

#### How to Connect

- Match and insert the yellow, red, and white A / V cables into the device and TV.

#### How to Use

- Press the **INPUT** button on the remote. Then use the ▼▲ arrow buttons to highlight **AV**. Press **ENTER**.





# Installation

## Connection to Antenna & Cable / Satellite Box

We recommend using a high quality roof top antenna, digital cable, or satellite box for the best display and performance.

**Note:** Reception quality is determined by your location, geographical terrain, distance from the local broadcast transmitter, and strength of antenna.

### Connecting to POWER IN

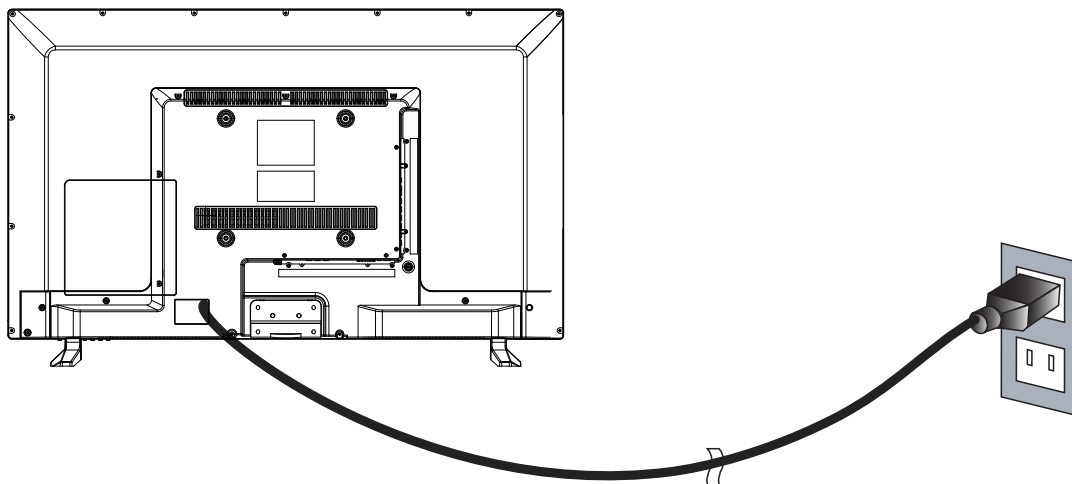

- Connect the power cord to a properly grounded AC outlet.

### Roof Antenna / Cable Outlet Installation



#### Connecting an antenna or basic cable service:

- Connect the RF coaxial (75 ohm) cable from existing roof top / in door antenna, or wall outlet.
- Finger tighten the Coaxial / RF Cable end to the TV input on the panel.

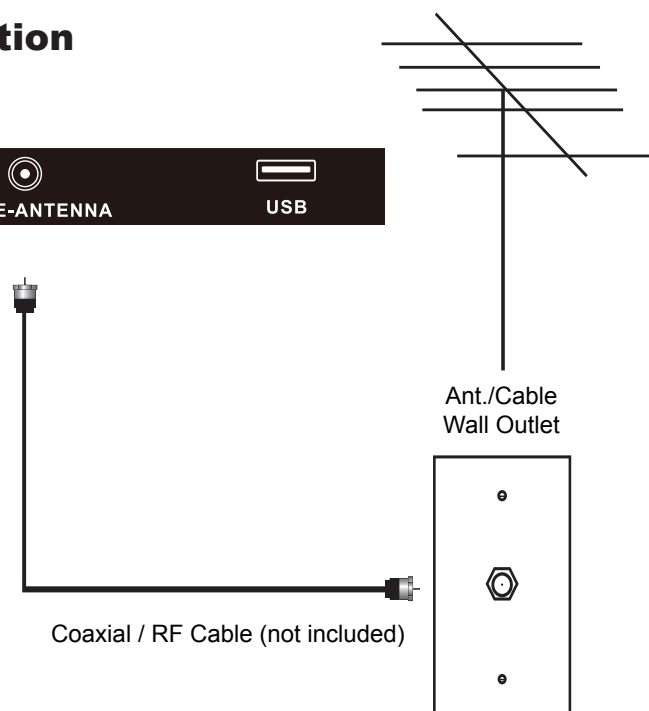

# Installation

## Connection to a Home Theater System

### Connection to a Home Theater Audio System

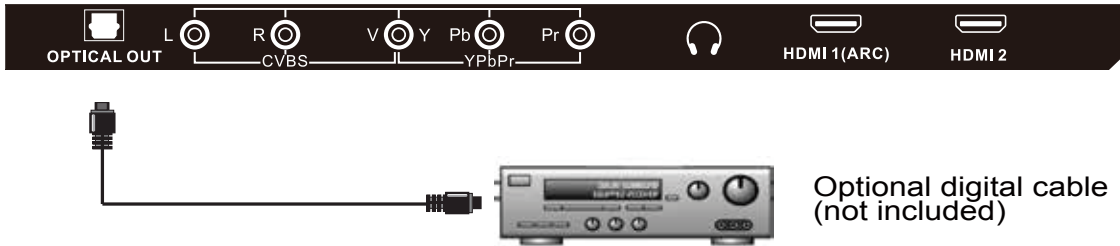

#### Connecting to a Home Theater System

Digital audio can deliver optimal 2 - channel stereo or 5.1 surround sound with Five discrete full range channels plus a separate channel for a subwoofer.

Connect an optional digital cable directly to the television's **OPTICAL OUT** audio output.

#### How To Setup Digital Output

- Press the **MENU** button on the remote control.
- Press the **▶** arrow button to select **Sound**.
- Press the **▼** arrow button to highlight **Digital Audio output**.
- Press **▶** to select **Raw** or **PCM**

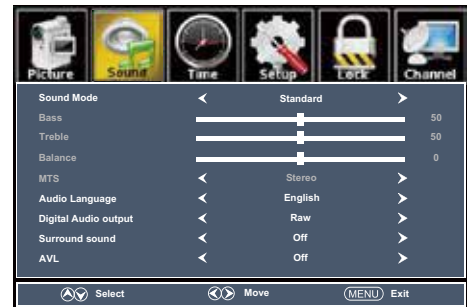

### Connecting to a Stereo Receiver / Amplifier

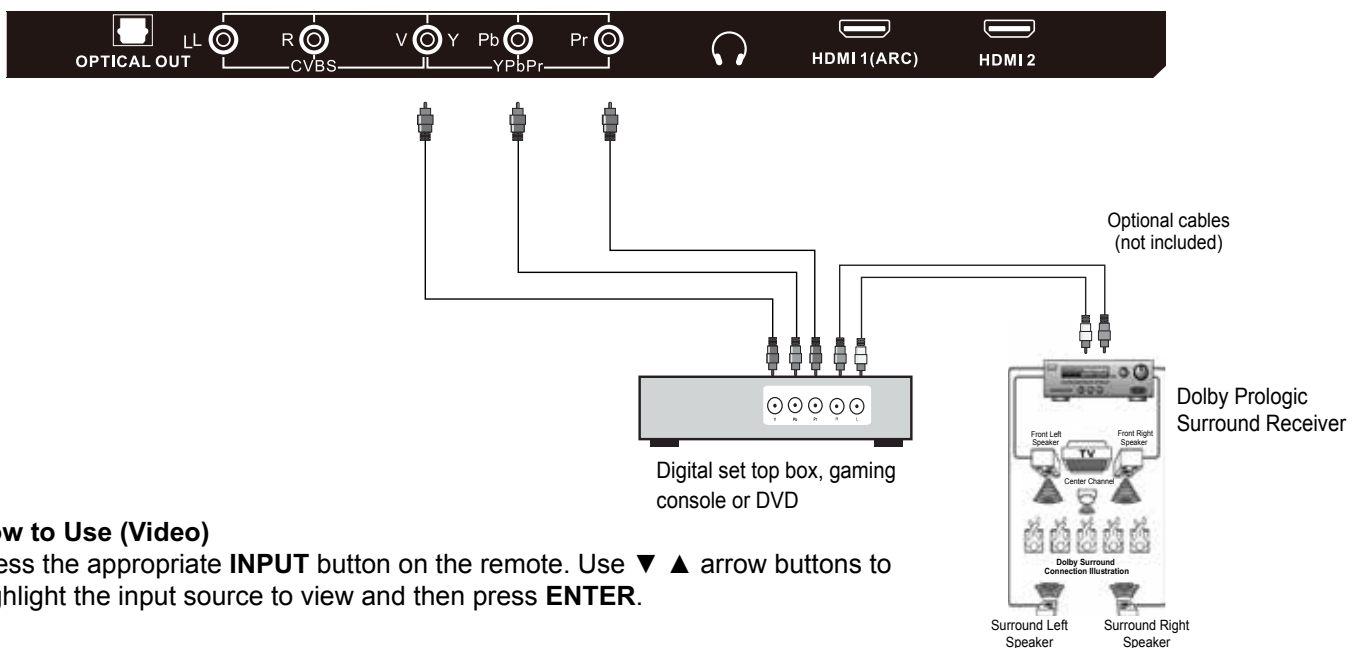

#### How to Use (Video)

Press the appropriate **INPUT** button on the remote. Use **▼ ▲** arrow buttons to highlight the input source to view and then press **ENTER**.

#### How to Use (Audio)

Select the appropriate input from your audio equipment.

\*NOTE: Refer to the User Manual from your home theater equipment for recommended audio settings.

**IMPORTANT NOTE:** If your TV is connected to a Cable or Satellite set top box **DO NOT** run the “Channel Auto Scan” in **STEP 3**.

### Initial Setup Wizard

After connecting your TV antenna or cable wire, turn the television ON.

The quick Setup Wizard will display on-screen to help guide you through the 3 steps listed below:

NOTE: the Setup Wizard only appears when turning on the TV for the first time.

### How to Navigate the Setup Menus:

Use the ▲▼ arrow buttons on the remote to move to the menu selection.

Use the ◀▶ arrow buttons on the remote to choose the desired menu option.

### STEP 1: Choosing a Menu Language

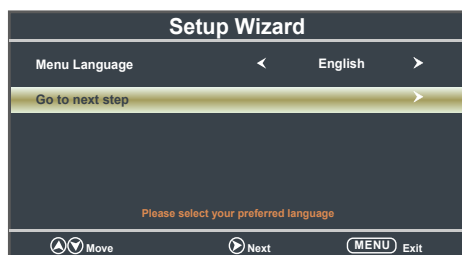

Use the ▲▼ arrow buttons to select **Menu Language**.

Use the ◀▶ arrow buttons to select **English - Francais - Español**.

Use the ▼ arrow button to select **Go to next step** and press the ▶ button to complete the step.

### STEP 2: Setting the Time

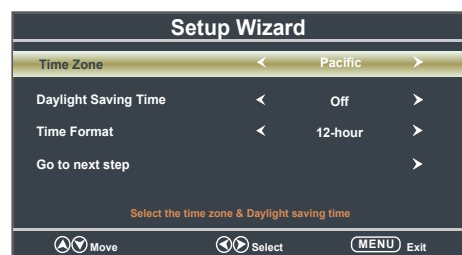

Use the ▲▼ arrow buttons to select **Time Zone**, **Daylight Saving Time**, and **Time Format** selections.

Use the ◀▶ arrow buttons to select the desired setting.

Use the ▼ arrow button to select **Go to next step** and press the ▶ button to complete the step.

**IMPORTANT NOTE:** If your TV is connected to a Cable or Satellite set top box **DO NOT** run the “Channel Auto Scan” in **STEP 3**.

### STEP 3: Setting Air/Cable and Channel Auto Scan

**Note:** Your type of television connection will determine if you should complete the Channel Auto Scan part of this step.

Use the ◀ ▶ arrow buttons to select **Air** or **Cable** based on your type of connection (Antenna or Cable without a set top box).



#### For Cable/Satellite Connections WITH a set top box:

Press the **MENU** button on the remote control to exit the **Setup Wizard**.

**NOTE:** You will see the message “PLEASE RUN AUTO SCAN” on the screen. Ignore this message as this is not necessary when using a set top box.

Press the **INPUT** button on the remote control to display the **Input Source** screen illustrated to the left.

Use the ▲ ▼ arrow buttons to highlight the input where the set top box was installed. Press **ENTER** to select the desired input.

Initial Setup is now complete. You may now begin enjoying your TV, or make further adjustments to the TV settings which are explained in the following pages of this manual.

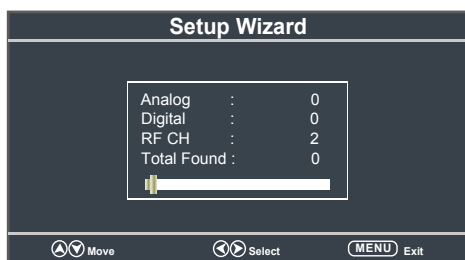
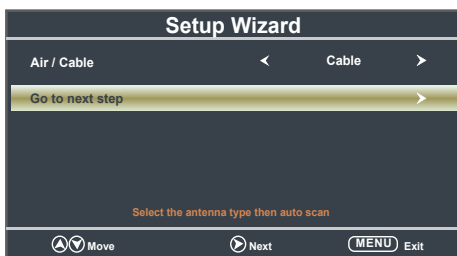

#### For Antenna & Cable Connections WITHOUT a set top box:

Use the ▼ arrow button to select **Go to next step** and press the ▶ button to begin the **Channel Auto Scan**.

**Channel Auto Scan** may take several minutes to complete.

Once **Channel Auto Scan** has ended, Initial Setup is complete. You may now begin enjoying your TV, or make further adjustments to the TV settings which are explained in the following pages of this manual.

# Menu Adjustments

## Picture Setting

The **Picture** menu offers options to enhance and refine the picture displayed on your TV based on ambient room light and personal preferences. Adjustment options include contrast, brightness, color, sharpness and color temperature.

### How to Navigate:

Press the **MENU** button on the remote control. Navigate using ◀ ▶ arrow buttons to select **Picture**. Press the down ▼ arrow button to highlight **Picture Mode**, then press the ▶ arrow button to select your viewing preference from 5 factory options: Standard - Dynamic - Soft - User - Power Saving. The Standard setting is recommended for most brightly lit viewing environments. Depending on the ambient light level in the room, you may find one of the other Picture settings more pleasing.

**To make more critical adjustments based on your own preferences select the User mode.**

- **Brightness**

Press down ▼ arrow button to highlight **Brightness**. Navigate using the ◀ ▶ arrow buttons to increase or decrease overall brightness.

- **Contrast**

Press down ▼ arrow button to highlight **Contrast**. Navigate using the ◀ ▶ arrow buttons to increase or decrease contrast intensity.

- **Color**

Press down ▼ arrow button to highlight **Color**. Navigate using the ◀ ▶ arrow buttons to increase or decrease color intensity.

- **Tint**

Press down ▼ arrow button to highlight **Tint**. Navigate using the ◀ ▶ arrow buttons to adjust colors toward green or reddish tint.

- **Sharpness**

Press down ▼ arrow button to highlight **Sharpness**. Navigate using the ◀ ▶ arrow buttons to soften or view crisper edges in the picture.

- **Color Temperature**

Press down ▼ arrow button to highlight your **Color Temperature** preference. Navigate using the ◀ ▶ arrow buttons to select Cool (more bluish tone), Normal or Warm setting.

- **Advanced Settings**

Adjust advanced video features to fine tune the picture.  
Press ▶ button to enter.



Note: When adjustments are completed, you may select another menu by pressing the **Menu** button.

# Menu Adjustments

## Audio Settings

The **Audio** menu offers options to make sound enhancements while listening through the built-in speakers or to select digital audio options when connected to a Dolby Digital receiver through an optical digital output.

### How to Navigate:

Press the **MENU** button on the remote control. Navigate using ◀▶ arrow buttons to select **Sound**. Press the ▼ arrow button to highlight **Sound Mode**, then press the ▶ arrow button to select your sound preference from 5 factory options: Music - Movie - Sports - User - Standard

#### • **Sound Mode**

Press down ▼ arrow button to highlight **Sound Mode**.

Press ◀▶ button to select Music - Movie - Sports - User - Standard.

- Music:** Preserves the original sound. Good for musical programs.
- Movie:** Enhances treble and bass for a rich sound experience.
- Sports:** Enhances vocals for TV audio.
- User:** Select to customize audio settings.
- Standard:** Produces a balanced sound in all environments.

#### • **Bass**

Press down ▼ arrow button to highlight **Bass**.

Press ◀▶ buttons to increase or decrease low frequency intensity.

#### • **Treble**

Press down ▼ arrow button to highlight **Treble**.

Press ◀▶ buttons to increase or decrease high frequency intensity.

#### • **Balance**

Press down ▼ arrow button to highlight **Treble**.

Press ◀▶ buttons to adjust sound towards the left or right speaker.

#### • **MTS**

Press down ▼ arrow button to highlight **MTS**.

Press ◀▶ button to select Mono - Stereo - SAP.

**Mono:** Sets the sound to mono.

**Stereo:** Sets the sound to stereo when stereo is not available. The sound is automatically switched to mono.

**SAP:** Sets the sound to the second audio program.

#### • **Audio Language**

Press down ▼ arrow button to highlight **Audio Language**.

Press ◀▶ button to select English - Francais - Español.



#### • **Digital Audio Output**

Press ▲▼ button to highlight **Digital Audio Output**.

Press ◀▶ button to select (Raw - Off - PCM)

#### • **Surround Sound**

Press ▲▼ button to select Surround Sound.

Press ◀▶ button to select (Off - On)

#### • **AVL**

Press down ▼ arrow button to highlight **AVL**.

Press ◀▶ button to select (Off - On)

Note: When adjustments are completed, you may select another menu by pressing the **Menu** button.

# Menu Adjustments

## Date & Time Settings

The **Time** menu includes adjustment of settings for your local time zone and daylight savings time. The clock will adjust automatically after the initial Channel Auto Scan of available broadcast channels in your area.

### How to Navigate:

Press the **MENU** button on the remote control. Navigate using arrow ◀ ▶ buttons to select **Time**.

- Press down ▼ arrow button to highlight **Sleep Timer** then press the ▶ arrow button to select time to view before the television timer turns the set off: 5 Min - 10 Min - 15 Min - 30 Min - 60 Min - 90 Min - 120Min - 180 Min - 240 Min - OFF.

- Press down ▼ arrow button to highlight **Time Zone** then press the ▶ arrow button to select between: Eastern - Central - Mountain - Pacific - Alaska - Hawaii - Samoa - Newfoundland - Atlantic.

- Press down ▼ arrow button to highlight **Daylight Savings Time**. Navigate using the ◀ ▶ arrow buttons to select On or Off.

- Press down ▼ arrow button to highlight **Time Format**. Navigate using the ◀ ▶ arrow buttons to select either 12-hour or 24-hour.

- Press down ▼ arrow button to highlight **Auto Clock**. Navigate using the ◀ ▶ arrow buttons to turn this feature **On or Off**.

- **Clock** and Date are automatically set the first time the tuner receives a broadcast channel.

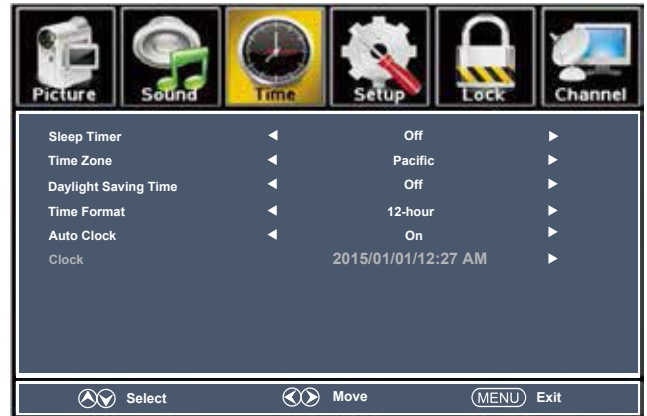

Note: When adjustments are completed, you may select another menu by pressing the **Menu** button.

# Menu Adjustments

## Setup Settings

In the **Setup** menu you may change the initial set up of preferences that include settings for language, menu display, computer monitoring, closed captions, enhancement of black detail in the picture and resetting your TV back to its factory default status.

### How to Navigate:

Press the **MENU** button on the remote control. Navigate using arrow ◀ ▶ buttons to select **Setup**. Gain access to display options by pressing the down ▼ arrow button to highlight **Menu Language** or other options, then press ▶ arrow button on your remote to select.



- **Menu Languages**

Other languages include English, Français, Español.



- **Transparent**

Navigate using the ◀ ▶ arrow buttons to adjust the transparency of the on screen display menu.



- **OSD Time Out**

Adjust the duration of the OSD (on screen display) menu. Press ◀ ▶ button to select.



- **Input Label**

Create labels for the devices connected to your TV. Press **ENTER** / ▶ button to enter.

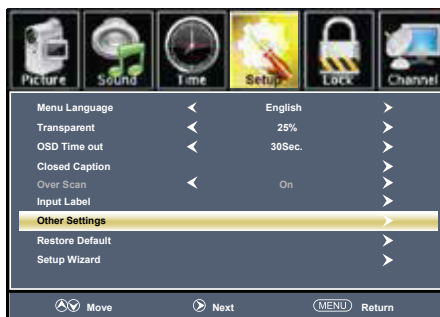

- **Other Settings**

Adjust the settings for Audio Only, No Signal Power Off, and No Operation Power Off. Press **ENTER** / ▶ button to enter.

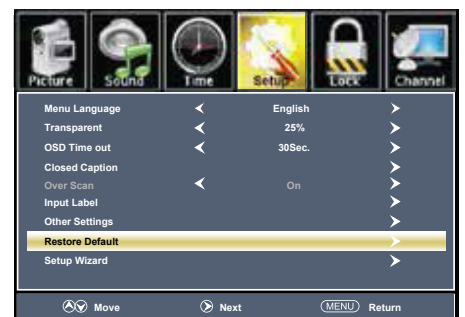

- **Restore Default**

Press the ▶ arrow button to automatically reset all adjustments back to their original factory settings. The TV will request confirmation.

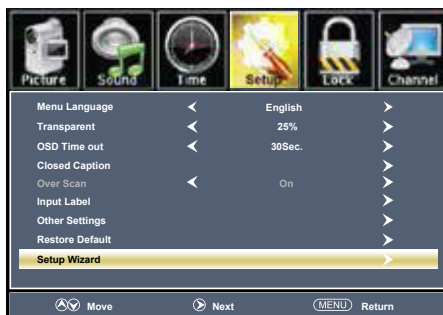

- **Setup Wizard**

Set the first time installation. Press **ENTER** / ▶ button to enter.

NOTE: Closed Caption and Advanced are features described on the following pages.



# Menu Adjustments

## Closed Captions

The **Setup** menu includes adjustments for activating the **Closed Caption** text feature for display on-screen and customizing CC display types and font styles.

### How to Navigate:

Press the **MENU** button on the remote control. Navigate using arrow ◀ ▶ buttons to select **Setup**.



- Press the down ▼ arrow button to highlight **Closed Caption** then press the ▶ arrow button to highlight **CC Mode**.



- Navigate using the ◀ ▶ arrow buttons to select **CC Off - CC On - CC on Mute**.

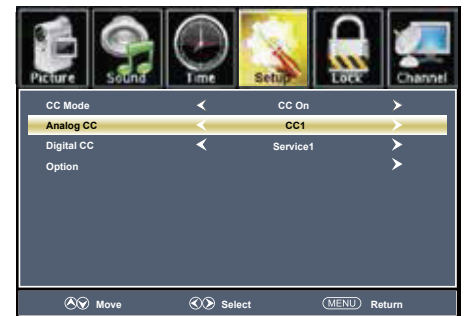

- Press down ▼ arrow button to highlight **Analog CC**. Navigate using the ◀ ▶ arrow buttons to select **CC1-4, TEXT1-4**.

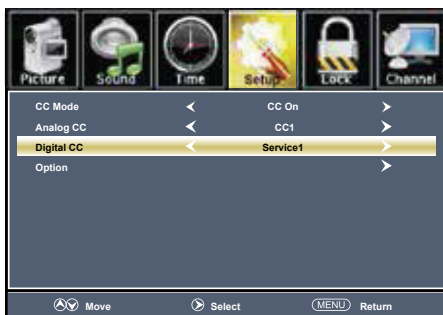

- Press down ▼ arrow button to highlight **Digital CC**. Navigate using the ◀ ▶ arrow buttons to select **Off, Service 1-6**.

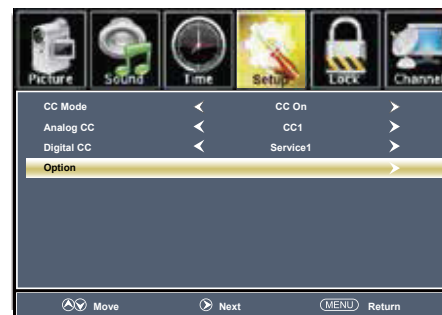

- Press down ▼ arrow button to highlight **Option**. Press the ▶ arrow button to enter a menu with options to customize text fonts, colors and opacities.

Note: When adjustments are completed, you may select another menu by pressing the **Menu** button.

# Menu Adjustments

## CEC Settings

The **CEC menu** includes options for controlling functions of compatible external devices connected via the HDMI input. Please refer to the instruction manual of your connected device to confirm if CEC control is possible.

### How to Navigate:

Press the **MENU** button on the remote control. Navigate using arrow ◀ ▶ buttons to select **Setup**



- Press the down ▼ arrow button to highlight **CEC** then press the ▶ arrow button to highlight **CEC Control**.

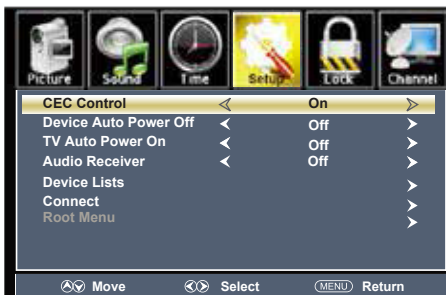

- Navigate using the ◀ ▶ arrow buttons to select **On - Off**. When you select **On**, the **CEC** functions open. Otherwise the **CEC** functions close.

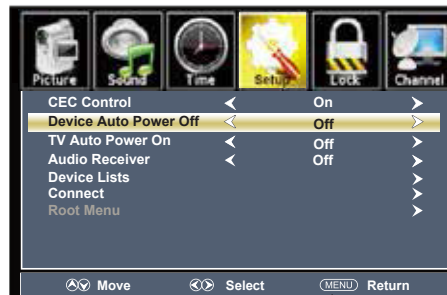

- Press the down ▼ arrow button to highlight **Device Auto Power Off**. Navigate using the ◀ ▶ arrow buttons to select **On - Off**.

If this item is "On", the external device will be turned off automatically when the TV is powered off



- Press down ▼ arrow button to highlight **TV Auto Power On**. Navigate using the ◀ ▶ arrow buttons to select **On - Off**

If this item is "On", when the TV is turned on, the external device will turn to HDMI mode automatically during powering on.



- Press down ▼ arrow button to highlight **Audio Receiver**. Press the ◀ ▶ arrow button to select **On - Off**.

If this item is "On", users can control the volume of the external amplifier through adjusting the TV's volume.



- Press the ▼ arrow button to highlight **Device Lists**. Press the ▶ arrow button to enter.

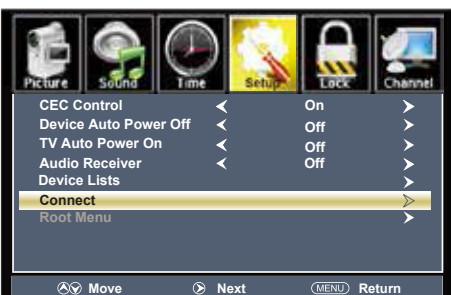

- Press the ▼ arrow button to highlight **Connect**. Press the ▶ arrow button to connect TV and DVD Player.

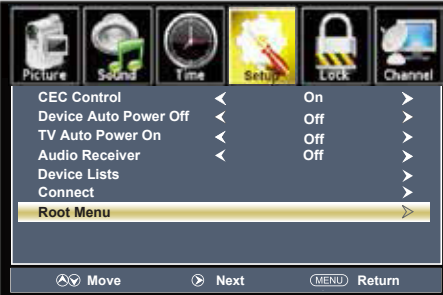

- Press the ▼ arrow button to highlight **Root Menu**. Press the ▶ arrow button to enter DVD menu.

Note: When adjustments are completed, you may select another menu by pressing the **Menu** button.

# Menu Adjustments

## USA Parental Control

In the **Lock** menu, you may block television and movie programming based on TV ratings and Motion Picture Association guidelines. To gain access and select your preferences within the Parental menu make certain your input is set to TV.

### How to Navigate:

Press the **MENU** button on the remote control. Navigate using arrow ◀ ▶ buttons to select **Lock**. Gain access to parental rating options by pressing the down ▼ arrow button to highlight **Enter Password**. Enter your 4 digit code (factory default code is "0000") unless previously changed.

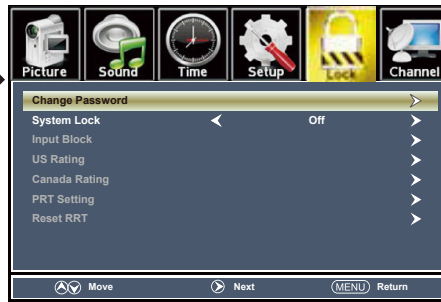
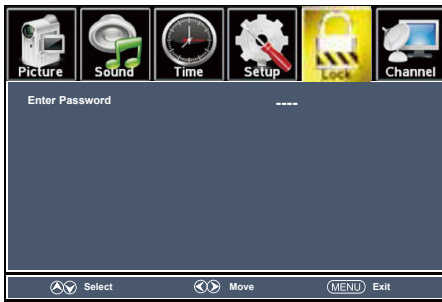

- To change the password, press ▶ arrow button to display a screen to enter your new password, then confirm again. (not illustrated)

- To make changes to parental controls, highlight **System Lock** then press the ◀ ▶ arrow button to ON.

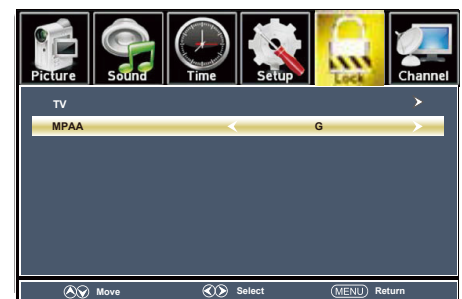
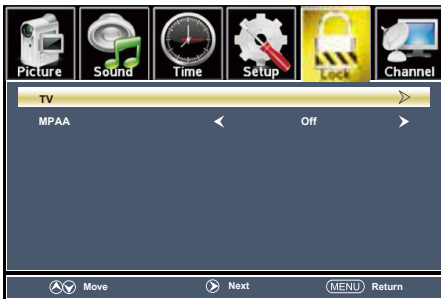

- To set parental controls for television programming or DVD movies, press the ▼▲ arrow buttons to highlight US Rating. Navigate using the ◀ ▶ buttons to highlight **TV / MPAA** menu.

- Highlight TV, then press the ▶ arrow button to enter the TV Ratings menu and select your preference.

- Highlight MPAA, then press the ▶ arrow button repeatedly to select your movie rating preference.

**TV-Y** Appropriate for all children  
**TV-Y7** Appropriate for children over 7  
**TV-G** General Audience  
**TV-PG** Parental Guidance Suggested  
**TV-14** Parents Strongly Cautioned  
**TV-MA** Mature Audience Only

**G** General Audience  
**PG** Parental Guidance Suggested  
**PG-13** Parents Strongly Cautioned  
**R** Restricted  
**NC-17** No One Under 17 Permitted  
**X** Adults Only

NOTE: PRT Setting and Reset RRT are not user adjustable settings.

# Menu Adjustments

## Canadian Parental Control

In the **Lock** menu, you may block television and movie programming based on Canadian TV and movie rating guidelines. To gain access and select your preferences within the Parental menu make certain your input is set to TV.

### How to Navigate:

Press the **MENU** button on the remote control. Navigate using arrow ◀ ▶ buttons to select **Lock**. Gain access to rating options by pressing the ▼ arrow button to highlight **Enter Password**. Enter your 4 digit code (The factory default code is "0000") unless previously changed. Then press the ▼▲ arrow buttons to highlight Canada. Navigate using the ◀ ▶ buttons to highlight **Canada English**.

• Navigate using the ▼ arrow button to highlight **Canada English** then press the ◀ ▶ arrow button repeatedly to select your ratings preference.



Off	Turn Off
C	Appropriate for all children
C8+	Appropriate for everyone 8 years old and up
G	General Audience
PG	Parental Guidance
14+	Appropriate for Children over 14 years old
18+	Mature Audience Only

• Navigate using the ▼ arrow button to highlight **Canada French** then press the ◀ ▶ arrow button repeatedly to select your ratings preference.

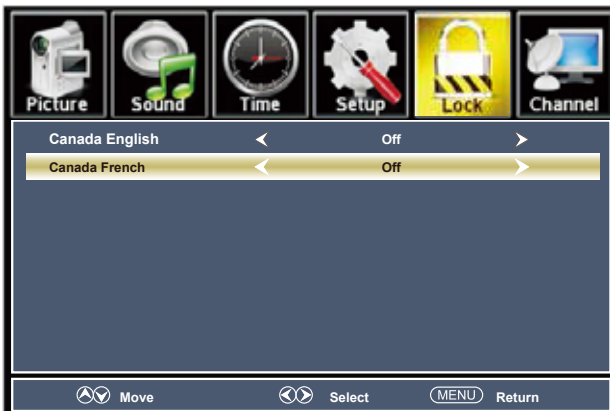

Off	Turn Off
G	General Audience
8 ans+	Appropriate for Children 8 years old and up
13 ans+	Appropriate for Children 13 years old and up
16 ans+	Appropriate for Children 16 years old and up
18 ans+	Mature Audience Only

Note: When adjustments are completed, you may select another menu by pressing the **Menu** button.

# Menu Adjustments

## Channel Settings

The **Channel** menu provides the setup / changes of your television to receive broadcast channels, store your favorite channels, add or skip channels in memory, and label or name channels.

### How to Navigate:

Press the **MENU** button on the remote control. Navigate using arrow ◀ ▶ buttons to select **Channel**. Press the down ▼ button to highlight your preferences.

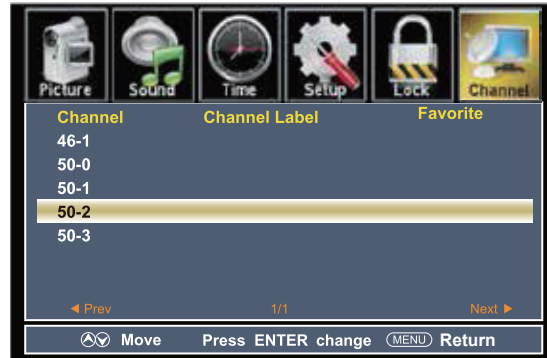
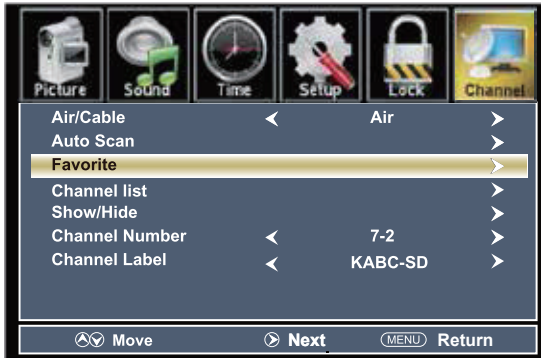

### • Favorite

• Highlight **Favorite** to add channels to your Favorites List. Navigate using the ◀▶▼▲ arrow buttons to select channels to be added or deleted from your list. Press **ENTER** to add or delete a channel. A checkmark indicates a channel has been added. You may also display your list of **Favorite** channels by pressing the **FAV** button on the remote control

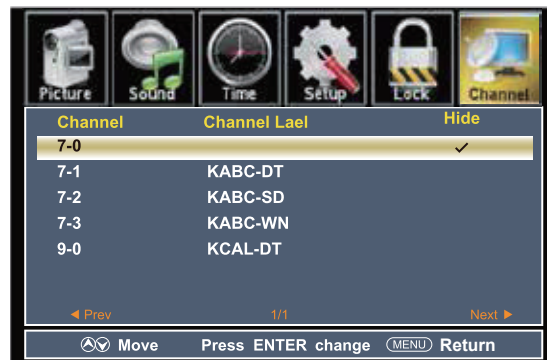

### • Show / Hide

• Highlight **Show / Hide** to select or skip channels already in memory. Navigate using the ◀▶▼▲ arrow buttons to access the list of available channels. Press **ENTER** to change the channels status. A checkmark indicates a channel has been added.



### • Channel Label

• Highlight **Channel Label** to name or rename a broadcast channel. Navigate using the ▶ arrow button to enter the screen menu to re-label a channel. Use the ▼▲ arrow buttons to spell out each letter, number or character. Use ◀ ▶ arrow buttons to advance to the next space.

# TV Settings

## TV Provider Changes & Channel Auto Scan After Initial Setup

To make changes your TV provider or re-scan for available broadcast channels in your area, select the **Channel Menu**.

Note: For Cable or Satellite users with a set-top box, there is no need to run Channel Auto Scan. Connect your cable satellite set top box to one of the available inputs on the TV for viewing.

### To enter the Channel Menu:

- Press the **MENU** button
- Using the ◀ ▶ arrow buttons; scroll to highlight **Channel**
- Press the down ▼ arrow buttons to highlight **Air / Cable**

### Cable Mode

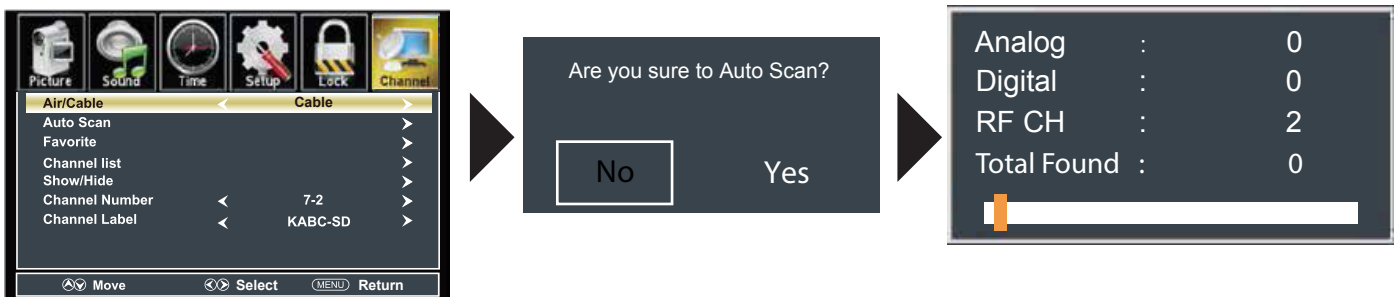

Select **Cable** if you subscribe to a pay television service without a set top box.

- Press the ◀ ▶ arrow buttons to highlight **Cable**
- Press the ▼ arrow button to highlight **Auto Scan** and press **ENTER**. Press the ▶ arrow button to highlight **YES** and press **ENTER** to begin **Auto Scan**.

NOTE: Channel Auto Scan may take several minutes to complete.

### Air Mode

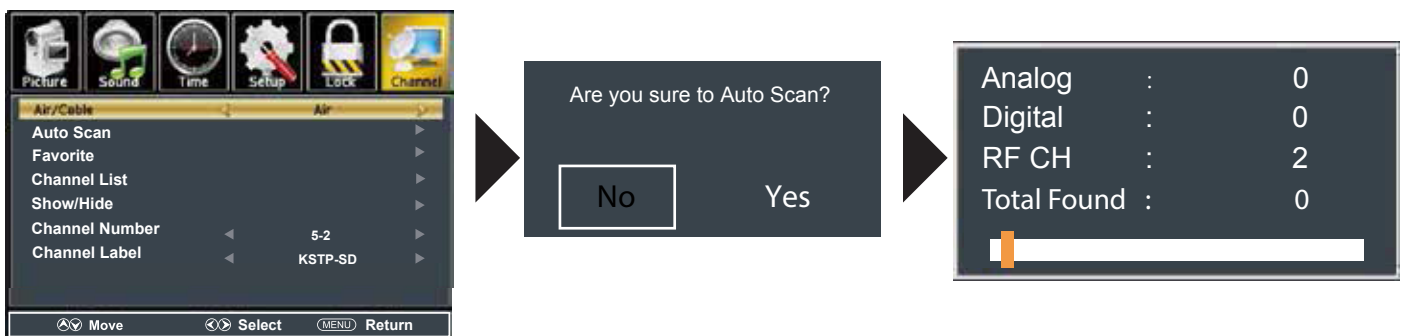

Select **Air** when TV is connected to an indoor / outdoor antenna.

- Press the ◀ ▶ arrow button to highlight **Air**.
- Press the ▼ arrow button to highlight **Auto Scan** and press **ENTER**. Press the ▶ arrow button to highlight **YES** and press **ENTER** to begin **Auto Scan**.

NOTE: Channel Auto Scan may take several minutes to complete.

# Aspect Modes

The ASPECT function offers several viewing display options on the 16:9 screen. Press the **ASPECT** button to cycle through the following widescreen settings.

NOTE: The ASPECT function is not available for digital broadcasts.

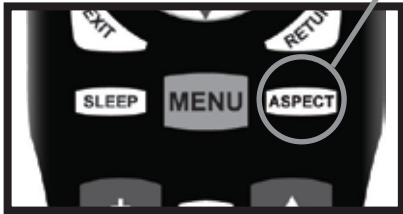

Press **ASPECT** to cycle through the following widescreen settings.

## 1. NORMAL

Recommended for viewing native widescreen content and undistorted 4:3 images (with black bars).



## 2. WIDE

Stretches certain 4:3 content and may reduce visible black bars.



## 3. ZOOM

Stretches the image both vertically and horizontally to fill the screen when viewing widescreen content. The Zoom effect will crop images somewhat.



## 4. CINEMA

When viewing 4:3 content, Cinema mode will fill the entire screen eliminating visible side black bars. It may also eliminate or reduce black bars on certain widescreen movies.



# USB Modes

1. Press the **INPUT** button on the remote control to display the Input menu. Use the **▲▼** buttons to select **MEDIA**.

Press the **▲▼** buttons to select **MEDIA** in the Source menu, and then press the **ENTER** button to enter.



• Press the **◀/▶** buttons to select Photo or Music, and then press the **ENTER** button to enter the chosen menu.

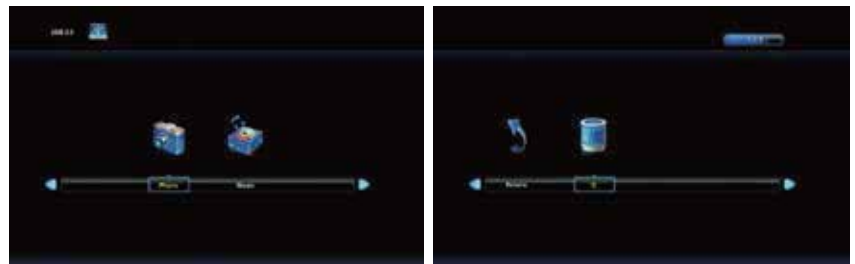

## To View Photos on the TV:

- Press the **◀/▶** buttons to select Photo and then press the **ENTER** button.
- Press the **◀/▶** buttons to select the photo you want to view and press the **ENTER** button.
- Press the **▲ / ▼ / ◀ / ▶** buttons to select other pictures to view from the on-screen options.
- To return to the previous menu screen, press the **RETURN** button.

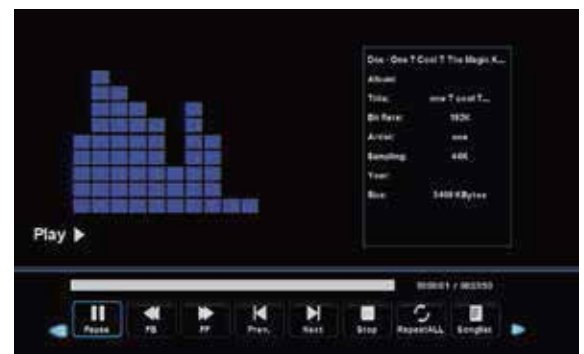

Press the **▲ / ▼ / ◀ / ▶** buttons to highlight the different playback functions (Play, Pause, Next, etc.) then press **ENTER** to select the highlighted function.



# MHL Setting

## Connecting an MHL-enabled device

You can connect a MHL-enabled device, such as certain models of smartphones & tablets, and view the device's screen on the TV.

Connecting a MHL-enabled device to the HDMI4 (MHL) input requires a special MHL cable. (Not included)

### To connect an MHL-enabled device:

1. Press **INPUT** to open the TV Input Source list.
2. Press **▲** or **▼** to select **HDMI4**, then press **ENTER**.
3. Connect a MHL cable to the micro USB port on the device, then connect the other end of the cable to the HDMI4 (MHL) jack on the TV.

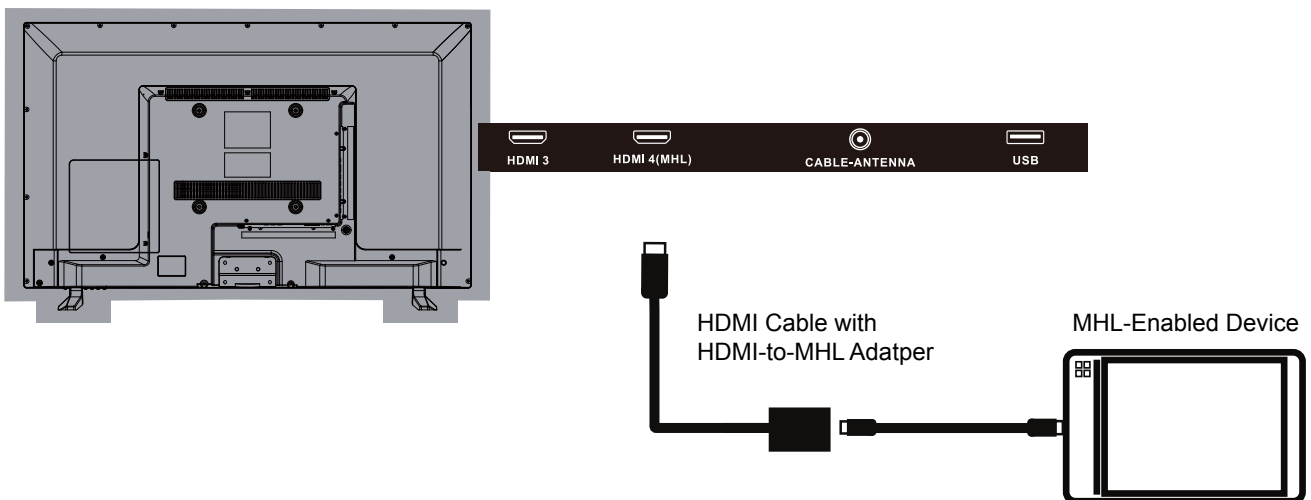

4. You should now see the screen image of your connected device on the TV.

# Specifications

<b>Display</b>	UHD LED
<b>Size (inch)</b>	40" Diagonal
<b>Aspect Ratio</b>	16:9
<b>Digital Compatibility</b>	480p/720p/1080i/1080p/2160p
<b>Resolution</b>	3840x2160
<b>Brightness (cd/m2)</b>	200
<b>Dynamic Contrast Ratio</b>	4000:1
<b>Vertical Viewing Angle (degrees)</b>	178°
<b>Horizontal Viewing Angle (degrees)</b>	178°
<b>Maximum Colors (millions)</b>	16.7M
<b>Power Consumption</b>	90 W
<b>Audio Power</b>	2 x 8W
<b>Dimension without Stand</b>	36.6" (W) x 21.8" (H) x 3.3" (D)
<b>Weight (may vary <math>\pm</math> 10%)</b>	17 lbs
<b>Input Connections</b>	Composite Video (1) Y Pb Pr (1) HDMI (4) HDMI with MHL (1) CABLE-ANTENNA (1) Optical (1) AUDIO out (1) USB (1)

# Troubleshooting

Symptom	Possible Solutions
Cannot receive certain channels through the antenna	<ul style="list-style-type: none"> <li>Perform Channel Scan to add channels into the TV tuner memory. See page 29.</li> <li>Readjust your antenna and retry Auto Channel Scan.</li> <li>Signal from the TV station may be weak in your area.</li> </ul>
No color	<ul style="list-style-type: none"> <li>Check the video installation of your external A / V equipment. See pages 13-17.</li> </ul>
Video noise or choppy picture	<ul style="list-style-type: none"> <li>Readjust antenna. Keep TV away from noise sources, neon lights, and microwave appliances.</li> </ul>
TV blocked on certain channels	<ul style="list-style-type: none"> <li>Perform Channel Scan to add channels into the TV tuner memory. See page 19.</li> <li>Check whether the channel was deleted. See page 28.</li> <li>Check parental control settings. See page 26,27.</li> <li>Restore default settings. See page 23.</li> </ul>
Cannot use certain functions	<ul style="list-style-type: none"> <li>If the item chosen in a menu is shown in gray text, that item cannot be selected in the current input.</li> </ul>
No sound	<ul style="list-style-type: none"> <li>Check that connected audio cables are completely inserted.</li> <li>Verify you have selected the correct audio source from your amplifier. See page 21.</li> <li>Mute function may be enabled, press mute on the remote.</li> </ul>
Black box on screen	<ul style="list-style-type: none"> <li>The "Text" option is enabled and no text is available.</li> <li>Press the CCD button on the remote control to turn off.</li> </ul>
No power	<ul style="list-style-type: none"> <li>Batteries in the remote control may need replacing.</li> <li>Re-attach AC plug to wall outlet.</li> </ul>
No picture	<ul style="list-style-type: none"> <li>Digital TV channel signal maybe weak, try another channel.</li> <li>Press INPUT button to verify the desired input selected.</li> <li>Re-connect the antenna or cable wiring.</li> <li>Restore default settings. See page 23.</li> </ul>
Remote control does not function	<ul style="list-style-type: none"> <li>Replace batteries with new ones.</li> <li>Check that battery polarity is correct.</li> <li>Point remote directly at the TV's IR receiver. See page 11.</li> </ul>